

DOGHER

© TOOLS



547



564



579



551



567



580



553



574



581



562



575



583

Anti-faísca
Cu-Be 10000
Al-Br 15000



Liga de Cobre-Berílio / Alumínio-Bronze



Cu-Be

Composição:

Be 1,8% - 2,3%
Co+Ni > 0,2%
Otros < 1,2%
Cu - O resto

Dureza: 283-365 HB

Resistência à tração: 1250 N/mm²

Al-Br

Composição:

Al 10% - 12%
Ni 4% - 6%
Fe+Mn < 5,8%
Otros - 0,5%
Cu - O resto

Dureza: 221-291 HB

Resistência à tração: 800 N/mm²

A Segurança das Ferramentas Anti-faísca da DOGHER TOOLS é credenciada pelo Instituto Federal Alemão de Pesquisa e Exame de Materiais BAM, um membro notificado da União Europeia para certificação de acordo com a Diretiva 94/9 / EG (ATEX). Assim como pela FM APPROVED, uma das seguradoras de maior prestígio no mundo, especializada na análise e prevenção dos riscos no setor da construção.

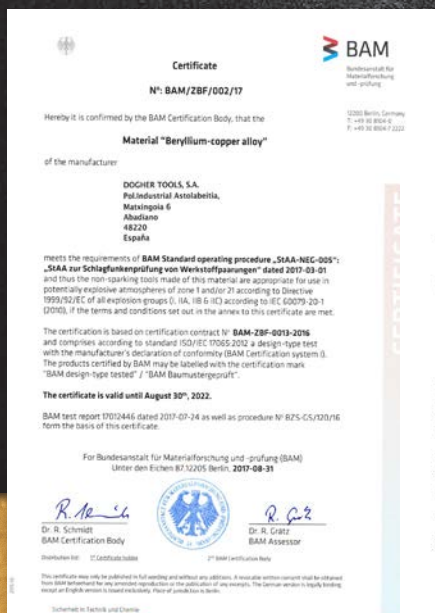

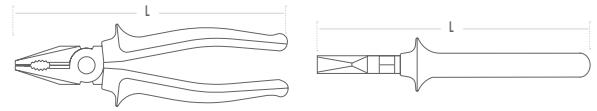

10200
15200

Alicates Gasista

Cu-Be

Al-Br

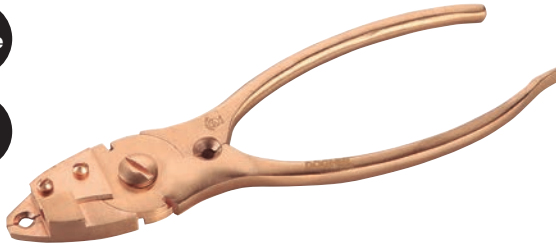

		Cu-Be		Al-Br	
L mm	L"	Part N°	€	Part N°	€
180	7	10200-160	282,10	15200-160	198,42

10205
15205

Alicates Professional Universal

Cu-Be

Al-Br

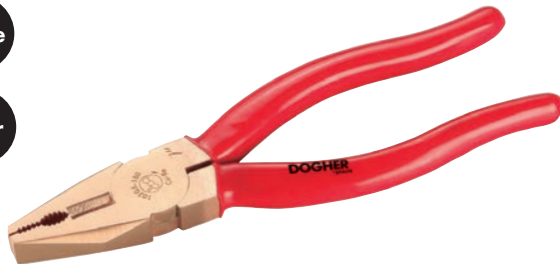

		Cu-Be		Al-Br	
L mm	L"	Part N°	€	Part N°	€
160	6	10205-160	211,59	15205-160	176,02
180	7	10205-180	229,22	15205-180	180,17
200	8	10205-200	246,84	15205-200	184,64

10212
15212

Alicates Professional de Corte Diagonal

Cu-Be

Al-Br

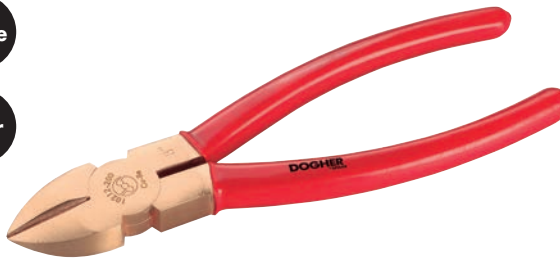

		Cu-Be		Al-Br	
L mm	L"	Part N°	€	Part N°	€
160	6	10212-160	264,48	15212-160	178,98
200	8	10212-200	276,31	15212-200	193,91

10213
15213

Alicates Professional de Corte Diagonal Reforçado

Cu-Be

Al-Br



		Cu-Be		Al-Br	
L mm	L"	Part N°	€	Part N°	€
160	6	10213-160	278,83	15213-160	184,49
180	8	10213-180	293,53	15213-180	193,91

Cu-Be / Al-Br

Alicates Série Profissional Anti-faisca

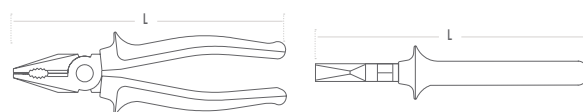

10210
15210

Alicates Profissional de Pontas Planas

Cu-Be

Al-Br



		Cu-Be		Al-Br	
L mm	L"	Part N°	€	Part N°	€
160	6	10210-160	193,94	15210-160	176,51

10211
15211

Alicates Profissional de Pontas Redondas

Cu-Be

Al-Br



		Cu-Be		Al-Br	
L mm	L"	Part N°	€	Part N°	€
160	6	10211-160	193,94	15211-160	176,51

10208
15208

Alicates Profissional de Pontas Semirredondas com Corte

Cu-Be

Al-Br

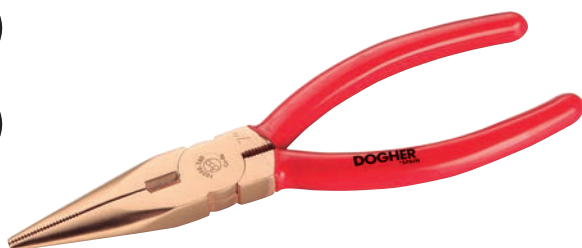

		Cu-Be		Al-Br	
L mm	L"	Part N°	€	Part N°	€
150	6	10208-160	211,59	15208-160	163,70
180	7	10208-180	229,22	15208-180	171,76
200	8	10208-200	246,84	15208-200	172,61

10215
15215

Alicates Profissional para Descarnar

Cu-Be

Al-Br

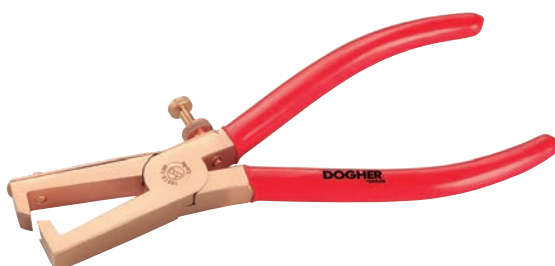

		Cu-Be		Al-Br	
L mm	L"	Part N°	€	Part N°	€
170	7	10215-160	405,53	15215-160	183,63

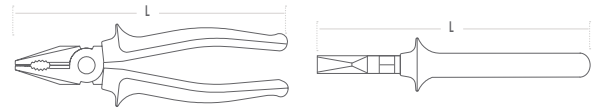

10219
15219

Alicate Gasista

Cu-Be

Al-Br



		Cu-Be		Al-Br	
L mm	L"	Part N°	€	Part N°	€
200	8	10219-200	176,32	15219-200	149,87

10220
15220

Alicate Pontas Retas Freio Exterior

Cu-Be

Al-Br

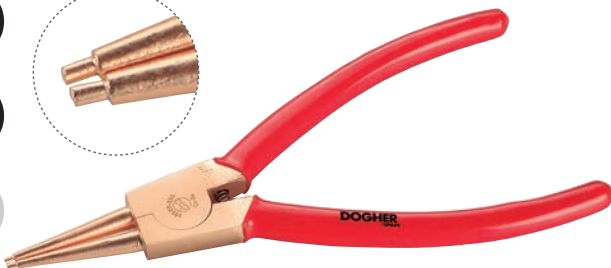

		Cu-Be		Al-Br	
L mm	L"	Part N°	€	Part N°	€
200	8	10220-220	299,74	15220-220	239,22

10222
15222

Alicate Pontas Retas Freio Interior

Cu-Be

Al-Br

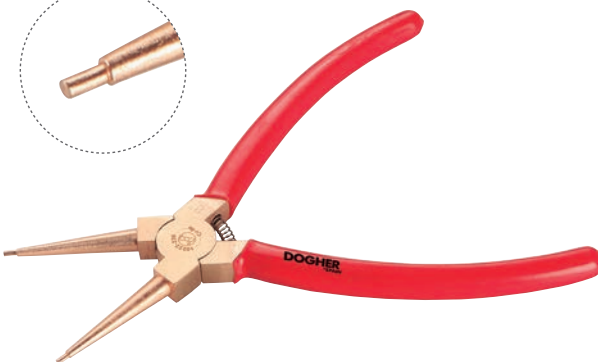
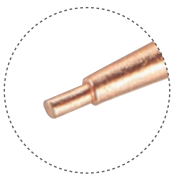

		Cu-Be		Al-Br	
L mm	L"	Part N°	€	Part N°	€
200	8	10222-220	299,74	15222-220	239,37

Cu-Be / Al-Br

Alicates e Turquesas Anti-faixa



10266
15266

Alicate Ajustável de Abertura Múltipla

Cu-Be

Al-Br



		Cu-Be			Al-Br	
L mm	L"	Ø mm	Part N°	€	Part N°	€
250	10	45	10266-250	277,83	15266-250	205,12
300	12	55	10266-300	336,30	15266-300	248,39

10270
15270

Turquês Profissional Alta Potência

Cu-Be

Al-Br



		Cu-Be			Al-Br	
L mm	L"	Ø mm	Part N°	€	Part N°	€
200	8	13	10270-200	232,09	15270-200	186,09

10273
15273

Turquês de Carpinteiro Profissional

Cu-Be

Al-Br



		Cu-Be		Al-Br	
L mm	L"	Part N°	€	Part N°	€
175	7	10273-180	381,21	15273-180	306,84
200	8	10273-200	384,70	15273-200	306,84

Prof

Cu-Be / Al-Br

Chaves de Parafusos Série Profissional Anti-faísca



As chaves da Série Profissional da Dogher, estão compostas por:

- Punho Bimaterial; elastômero anti-derrapante no 70% do corpo.
- Vareta Cu-Be/Al-Br: Uso profissional.



10330 15330

Ponta Fenda Plana



Cu-Be

Al-Br



Cu-Be

Al-Br

10331 15331

Ponta Fenda Reto



Cu-Be

Al-Br

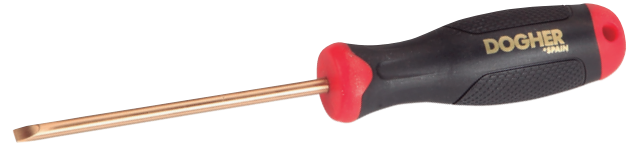

Cu-Be

Al-Br

A mm	L mm	L "	Part N°	€	Part N°	€
3	50	2	10330-030-050	26,45	15330-030-050	24,61
3	75	3	10330-030-075	29,98	15330-030-075	28,16
4	75	3	10330-040-075	33,50	15330-040-075	28,43
4,5	50	2	10330-045-050	29,98	15330-045-050	27,17
4,5	100	4	10330-045-100	38,91	15330-045-100	32,39
5	75	3	10330-050-075	35,26	15330-050-075	29,73
5	100	4	10330-050-100	38,80	15330-050-100	32,43
6	100	4	10330-060-100	42,32	15330-060-100	37,09
6	125	5	10330-060-125	42,32	15330-060-125	38,35
6	150	6	10330-060-150	51,95	15330-060-150	40,01
7	150	6	10330-070-150	51,87	15330-070-150	40,01
8	150	6	10330-080-150	59,96	15330-080-150	46,67
8	200	8	10330-080-200	82,55	15330-080-200	63,35
9	250	10	10330-090-250	97,20	15330-090-250	75,01
10	200	8	10330-100-200	99,65	15330-100-200	76,70
10	300	12	10330-100-300	123,43	15330-100-300	100,01
11	250	10	10330-110-250	130,85	15330-110-250	91,69
11	300	12	10330-110-300	141,06	15330-110-300	108,35
11	350	14	10330-110-350	163,84	15330-110-350	125,03
12	400	16	10330-120-400	184,64	15330-120-400	131,69
13	450	18	10330-130-450	193,57	15330-130-450	141,70

A mm	L mm	L "	Part N°	€	Part N°	€
3	50	2	10331-030-050	35,26	15331-030-050	31,91
4	100	4	10331-040-100	44,08	15331-040-100	39,80
4	150	6	10331-040-150	76,18	15331-040-150	52,42
5	100	4	10331-050-100	79,14	15331-050-100	49,01
5	200	8	10331-050-200	88,17	15331-050-200	70,21
6	100	4	10331-060-100	88,17	15331-060-100	52,68
8	150	6	10331-080-150	103,57	15331-080-150	71,33
10	200	8	10331-100-200	123,43	15331-100-200	89,21
10	300	4	10331-100-300	154,25	15331-100-300	106,03

Cu-Be / Al-Br

Chaves de Parafusos Série Professional Anti-faixa



10334
15334

Ponta Phillips

10337
15337

Ponta Pozidriv



Cu-Be

Al-Br



Cu-Be

Al-Br



Cu-Be

Al-Br

Cu-Be

Al-Br

Icon	L mm	L "	Part N°	€	Part N°	€
PH0	50	2	10334-PH0-050	38,80	15334-PH0-050	33,12
PH1	100	4	10334-PH1-100	38,80	15334-PH1-100	36,46
PH2	125	5	10334-PH2-125	42,32	15334-PH2-125	38,45
PH3	150	6	10334-PH3-150	61,71	15334-PH3-150	54,90
PH4	300	12	10334-PH4-300	96,99	15334-PH4-300	81,12

Icon	L mm	L "	Part N°	€	Part N°	€
PZ0	50	2	10337-PZ0-050	38,80	15337-PZ0-050	31,79
PZ1	100	4	10337-PZ1-100	38,80	15337-PZ1-100	34,34
PZ2	125	4	10337-PZ2-125	42,32	15337-PZ2-125	37,20
PZ3	150	6	10337-PZ3-150	61,71	15337-PZ3-150	54,90
PZ4	150	6	10337-PZ4-300	96,99	15337-PZ4-300	81,12

10330
15330

Estojo de Plástico

5

Pcs



Cu-Be

Al-Br



Plana

5 • 6 • 8

PH1 • PH2



Part N°	€	Part N°	€
10330-005	222,18	15330-005	192,36

Cu-Be / Al-Br

Chaves de Dupla Boca Aberta Anti-faísca



10450
15450

Chave de Dupla Boca Aberta

Cu-Be

Al-Br

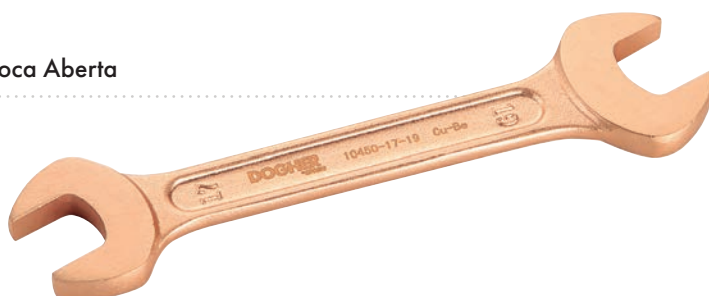

		Cu-Be				Al-Br				Cu-Be				Al-Br	
A mm	B mm	L mm	Part N°	€	Part N°	€	A mm	B mm	L mm	Part N°	€	Part N°	€		
6	7	92	10450-06-07	31,74	15450-06-07	26,07	22	27	215	10450-22-27	132,24	15450-22-27	117,04		
6	8	92	10450-06-08	31,74	15450-06-08	24,90	23	26	220	10450-23-26	135,77	15450-23-26	125,76		
7	8	96	10450-07-08	33,50	15450-07-08	27,72	24	25	230	10450-24-25	141,06	15450-24-25	127,85		
7	9	96	10450-07-09	33,50	15450-07-09	28,17	24	26	230	10450-24-26	144,56	15450-24-26	129,93		
8	9	100	10450-08-09	35,26	15450-08-09	27,72	24	27	230	10450-24-27	148,11	15450-24-27	142,15		
8	10	100	10450-08-10	37,03	15450-08-10	29,35	24	30	233	10450-24-30	156,92	15450-24-30	153,50		
9	10	110	10450-09-10	38,80	15450-09-10	29,84	25	28	236	10450-25-28	176,79	15450-25-28	165,24		
9	11	110	10450-09-11	40,55	15450-09-11	35,87	26	29	250	10450-26-29	179,97	15450-26-29	163,87		
10	11	115	10450-10-11	42,32	15450-10-11	37,86	27	29	250	10450-27-29	180,54	15450-27-29	163,87		
10	12	120	10450-10-12	45,83	15450-10-12	40,62	27	30	250	10450-27-30	180,54	15450-27-30	163,87		
10	13	124	10450-10-13	49,37	15450-10-13	41,31	27	32	255	10450-27-32	185,13	15450-27-32	183,55		
10	14	124	10450-10-14	49,37	15450-10-14	41,64	28	30	250	10450-28-30	185,94	15450-28-30	175,81		
11	13	128	10450-11-13	52,90	15450-11-13	47,40	30	31	265	10450-30-31	202,76	15450-30-31	182,09		
11	14	130	10450-11-14	52,90	15450-11-14	48,20	30	32	265	10450-30-32	240,01	15450-30-32	190,10		
12	13	128	10450-12-13	56,43	15450-12-13	48,97	30	34	270	10450-30-34	229,22	15450-30-34	201,89		
12	14	130	10450-12-14	56,43	15450-12-14	49,37	30	36	270	10450-30-36	229,22	15450-30-36	206,18		
13	15	133	10450-13-15	59,96	15450-13-15	54,18	32	34	270	10450-32-34	260,95	15450-32-34	214,40		
14	15	143	10450-14-15	63,47	15450-14-15	55,08	32	35	300	10450-32-35	260,95	15450-32-35	220,23		
14	16	150	10450-14-16	67,70	15450-14-16	64,34	32	36	300	10450-32-36	260,95	15450-32-36	223,06		
14	17	150	10450-14-17	70,53	15450-14-17	65,94	33	35	300	10450-33-35	282,10	15450-33-35	228,57		
16	17	157	10450-16-17	74,06	15450-16-17	66,49	34	36	300	10450-34-36	282,10	15450-34-36	234,40		
16	18	163	10450-16-18	77,58	15450-16-18	67,02	35	36	300	10450-35-36	290,92	15450-35-36	244,17		
17	19	170	10450-17-19	81,11	15450-17-19	76,18	36	38	330	10450-36-38	290,92	15450-36-38	279,46		
17	22	173	10450-17-22	91,69	15450-17-22	84,67	36	41	330	10450-36-41	308,56	15450-36-41	294,99		
18	19	179	10450-18-19	95,21	15450-18-19	86,07	36	42	330	10450-36-42	326,18	15450-36-42	310,51		
18	20	175	10450-18-20	98,74	15450-18-20	86,78	41	46	355	10450-41-46	387,90	15450-41-46	347,43		
19	20	182	10450-19-20	102,27	15450-19-20	88,18	46	50	370	10450-46-50	476,07	15450-46-50	426,09		
19	22	185	10450-19-22	105,79	15450-19-22	89,60	50	52	375	10450-50-52	528,97	15450-50-52	432,65		
19	24	190	10450-19-24	109,33	15450-19-24	93,10	50	55	385	10450-50-55	581,85	15450-50-55	439,18		
20	22	195	10450-20-22	109,33	15450-20-22	94,66	50	60	400	10450-50-60	622,57	15450-50-60	445,75		
21	22	200	10450-21-22	114,61	15450-21-22	95,45	50	62	400	10450-50-62	632,45	15450-50-62	452,31		
21	23	200	10450-21-23	114,61	15450-21-23	96,20	55	60	415	10450-55-60	775,81	15450-55-60	576,85		
22	23	210	10450-22-23	118,15	15450-22-23	109,91	60	65	435	10450-60-65	843,47	15450-60-65	603,08		
22	24	210	10450-22-24	118,15	15450-22-24	110,81	65	70	460	10450-65-70	898,75	15450-65-70	642,41		

Cu-Be / Al-Br

Jogos de Chaves de Dupla Boca Aberta Anti-faisca



10450
15450

Saco de Nylon

8

Pcs

Cu-Be

Al-Br



390 x 300 mm



- 6x7
- 8x9
- 10x11
- 12x13
- 14x15
- 16x17
- 18x19
- 20x22

Cu-Be

Al-Br

Part N°	€	Part N°	€
10450-001	507,81	15450-001	442,92

10450
15450

Saco de Nylon

12

Pcs

Cu-Be

Al-Br



620 x 350 mm



- 6x7
- 8x9
- 10x11
- 12x13
- 14x15
- 16x17
- 18x19
- 20x22
- 21x23
- 24x27
- 25x28
- 30x32

Cu-Be

Al-Br

Part N°	€	Part N°	€
10450-002	1.187,33	15450-002	1.036,61

10450
15450

Suporte de Plástico

6

Pcs

Cu-Be

Al-Br



• 6x7 • 8x9 • 10x11 • 12x13 • 14x15 • 16x17

Cu-Be		Al-Br	
Part N°	€	Part N°	€
10450-016	303,27	15450-016	262,20

8

Pcs

Cu-Be

Al-Br



• 6x7 • 8x9 • 10x11 • 12x13 • 14x15 • 16x17
• 18x19 • 20x22

Cu-Be		Al-Br	
Part N°	€	Part N°	€
10450-018	507,81	15450-018	442,92

10450
15450

Suporte de Plástico

10

Pcs

Cu-Be

Al-Br



• 6x7 • 8x9 • 10x11 • 12x13 • 14x15 • 16x17
• 18x19 • 20x22 • 21x23 • 24x27

Cu-Be		Al-Br	
Part N°	€	Part N°	€
10450-020	770,53	15450-020	681,27

12

Pcs

Cu-Be

Al-Br



• 6x7 • 8x9 • 10x11 • 12x13 • 14x15 • 16x17
• 18x19 • 20x22 • 21x23 • 24x27 • 25x28 • 30x32

Cu-Be		Al-Br	
Part N°	€	Part N°	€
10450-022	1.187,33	15450-022	1.036,61

Cu-Be / Al-Br

Chaves de Boca / Luneta Anti-faixa

- Distribuição ótima das cargas
- Fixação rápida
- Máximo rendimento sem desgaste
- Diminuição dos danos em porcas e parafusos
- Maior vida útil da chave
- Máxima superfície de contato
- Distribuição homogênea do esforço

Efeito do esforço:

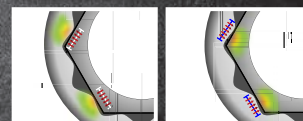

- Sobre a chave
- Sobre a porca

10451
15451

Chave de Boca / Luneta

Cu-Be

Al-Br

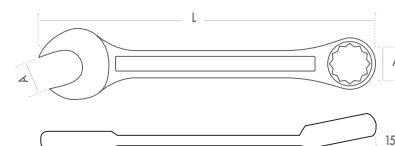

		Cu-Be		Al-Br	
A mm	L mm	Part N°	€	Part N°	€
6	105	10451-06	44,76	15451-06	31,26
7	120	10451-07	48,35	15451-07	33,74
8	120	10451-08	52,50	15451-08	37,50
9	135	10451-09	57,30	15451-09	39,98
10	135	10451-10	60,70	15451-10	47,50
11	150	10451-11	65,61	15451-11	56,25
12	150	10451-12	72,18	15451-12	66,26
13	175	10451-13	75,45	15451-13	69,95
14	175	10451-14	78,75	15451-14	73,59
15	195	10451-15	90,23	15451-15	80,31
16	195	10451-16	93,50	15451-16	90,20
17	195	10451-17	106,64	15451-17	103,07
18	215	10451-18	111,56	15451-18	104,93
19	215	10451-19	114,84	15451-19	106,75
20	215	10451-20	118,11	15451-20	110,44
21	245	10451-21	127,95	15451-21	114,12
22	245	10451-22	131,25	15451-22	123,29
23	265	10451-23	137,80	15451-23	127,00
24	265	10451-24	155,84	15451-24	136,21
25	265	10451-25	164,04	15451-25	146,36
26	290	10451-26	172,25	15451-26	152,96
27	290	10451-27	180,45	15451-27	156,81

		Cu-Be		Al-Br	
A mm	L mm	Part N°	€	Part N°	€
28	290	10451-28	213,27	15451-28	192,10
29	320	10451-29	221,46	15451-29	196,55
30	320	10451-30	229,67	15451-30	212,21
31	340	10451-31	262,48	15451-31	246,61
32	340	10451-32	270,68	15451-32	257,33
33	340	10451-33	324,83	15451-33	259,49
34	360	10451-34	327,27	15451-34	265,92
35	360	10451-35	331,14	15451-35	268,07
36	360	10451-36	340,24	15451-36	289,49
38	430	10451-38	353,89	15451-38	310,95
40	430	10451-40	377,32	15451-40	340,98
41	430	10451-41	401,93	15451-41	366,71
42	430	10451-42	475,74	15451-42	402,09
46	480	10451-46	492,16	15451-46	426,76
50	520	10451-50	541,36	15451-50	471,75
52	520	10451-52	626,48	15451-52	509,28
55	560	10451-55	606,98	15451-55	514,65
60	595	10451-60	672,62	15451-60	557,55
65	595	10451-65	913,65	15451-65	642,41
70	630	10451-70	1.029,85	15451-70	694,85
75	630	10451-75	1.154,93	15451-75	757,47
80	660	10451-80	1.368,99	15451-80	883,73

10451
15451

Saco de Nylon

14

Pcs

Cu-Be

Al-Br



650 x 440 mm



Cu-Be		Al-Br	
Part N°	€	Part N°	€
10451-002	1.651,86	15451-002	1.486,70

17

Pcs

Cu-Be

Al-Br



470 x 450 mm



Cu-Be		Al-Br	
Part N°	€	Part N°	€
10451-003	1.449,69	15451-003	1.289,14

10451
15451

Saco de Nylon

24

Pcs

Cu-Be

Al-Br



650 x 580 mm



Cu-Be		Al-Br	
Part N°	€	Part N°	€
10451-005	3.012,09	15451-005	2.686,24

26

Pcs

Cu-Be

Al-Br



650 x 500 mm



Cu-Be		Al-Br	
Part N°	€	Part N°	€
10451-006	3.195,15	15451-006	2.866,66

Cu-Be / Al-Br

Jogos de Chaves de Boca / Luneta Anti-faísca



10451
15451

Suporte de Plástico

8

Pcs

CrV

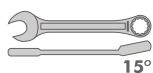

8 • 10 • 11 • 12 • 13 • 14 • 17 • 19

12

Pcs

CrV

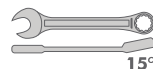

8 • 9 • 10 • 11 • 12 • 13
14 • 15 • 16 • 17 • 18 • 19

Cu-Be		Al-Br	
Part N°	€	Part N°	€
10451-018	626,67	15451-018	560,87

Cu-Be		Al-Br	
Part N°	€	Part N°	€
10451-022	979,26	15451-022	876,29

10454
15454

Chave de Lunetas

Cu-Be

Al-Br

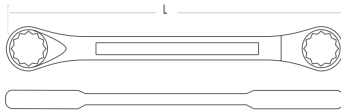

			Cu-Be		Al-Br	
mm	mm	L mm	Part N°	€	Part N°	€
6	7	95	10454-06-07	54,71	15454-06-07	39,64
7	9	115	10454-07-09	55,98	15454-07-09	40,44
8	9	115	10454-08-09	50,23	15454-08-09	42,05
9	11	125	10454-09-11	53,05	15454-09-11	44,50
10	11	140	10454-10-11	58,24	15454-10-11	45,39
10	12	140	10454-10-12	65,10	15454-10-12	47,15
12	14	145	10454-12-14	71,80	15454-12-14	48,94
13	15	155	10454-13-15	86,04	15454-13-15	58,14
14	17	165	10454-14-17	87,82	15454-14-17	59,28
16	18	170	10454-16-18	115,03	15454-16-18	77,29
17	19	185	10454-17-19	126,63	15454-17-19	85,08
17	22	200	10454-17-22	136,61	15454-17-22	93,59
18	19	185	10454-18-19	140,49	15454-18-19	94,15
19	21	200	10454-19-21	141,05	15454-19-21	105,51
19	22	200	10454-19-22	143,01	15454-19-22	108,02
20	22	200	10454-20-22	143,91	15454-20-22	110,58
21	23	220	10454-21-23	154,83	15454-21-23	119,26
22	24	220	10454-22-24	185,77	15454-22-24	132,55
24	27	255	10454-24-27	199,53	15454-24-27	153,23
25	28	265	10454-25-28	221,90	15454-25-28	171,30
26	28	265	10454-26-28	240,00	15454-26-28	178,14
27	30	280	10454-27-30	252,98	15454-27-30	181,77
27	32	295	10454-27-32	261,63	15454-27-32	200,52
30	32	295	10454-30-32	294,20	15454-30-32	212,86
30	36	330	10454-30-36	368,66	15454-30-36	266,07
32	36	330	10454-32-36	442,71	15454-32-36	319,28
36	41	365	10454-36-41	638,10	15454-36-41	461,00
41	46	405	10454-41-46	669,36	15454-41-46	546,56
46	50	425	10454-46-50	739,56	15454-46-50	622,20

Cu-Be / Al-Br

Chaves de Lunetas 75° Anti-faisca



10453
15453

Chave de Lunetas 75°

Cu-Be
Al-Br

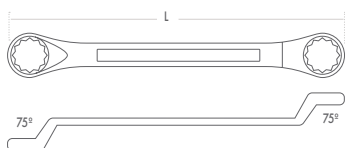

		Cu-Be			Al-Br	
mm	mm	L mm	Part N°	€	Part N°	€
6	7	180	10453-06-07	37,03	15453-06-07	34,62
8	9	190	10453-08-09	42,32	15453-08-09	40,98
10	11	215	10453-10-11	51,14	15453-10-11	46,76
12	13	225	10453-12-13	74,06	15453-12-13	72,43
14	15	255	10453-14-15	91,69	15453-14-15	84,49
14	17	255	10453-14-17	98,74	15453-14-17	90,58
16	17	280	10453-16-17	105,79	15453-16-17	94,68
16	18	280	10453-16-18	109,33	15453-16-18	104,23
18	19	280	10453-18-19	134,00	15453-18-19	112,85
20	22	320	10453-20-22	162,20	15453-20-22	125,59
21	23	320	10453-21-23	169,26	15453-21-23	131,08
22	24	330	10453-22-24	179,85	15453-22-24	151,86
24	26	340	10453-24-26	197,47	15453-24-26	162,04
24	27	340	10453-24-27	201,00	15453-24-27	154,23
25	28	350	10453-25-28	211,59	15453-25-28	162,04
27	29	350	10453-27-29	227,45	15453-27-29	178,41
30	32	370	10453-30-32	282,10	15453-30-32	218,44
34	36	430	10453-34-36	361,45	15453-34-36	278,04
36	41	470	10453-36-41	423,16	15453-36-41	325,51
41	46	500	10453-41-46	599,50	15453-41-46	461,15
46	50	525	10453-46-50	705,29	15453-46-50	542,52

10453
15453

Saco de Nylon

6

Pcs

Cu-Be

Al-Br



350 x 330 mm



• 6x7 • 8x9 • 10x11 • 12x13 • 14x15 • 16x17

Cu-Be

Al-Br

Part N°	€	Part N°	€
10453-001	402,01	15453-001	373,96

10453
15453

Saco de Nylon

8

Pcs

Cu-Be

Al-Br



390 x 380 mm

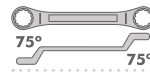

• 6x7 • 8x9 • 10x11 • 12x13 • 14x15
• 16x17 • 18x19 • 20x22

Cu-Be

Al-Br

Part N°	€	Part N°	€
10453-002	698,22	15453-002	612,40

10453
15453

Saco de Nylon

12

Pcs

Cu-Be

Al-Br



620 x 480 mm

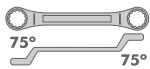

• 6x7 • 8x9 • 10x11 • 12x13 • 14x15 • 16x17
• 18x19 • 20x22 • 21x23 • 24x27 • 25x28 • 30x32

Cu-Be

Al-Br

Part N°	€	Part N°	€
10453-003	1.562,17	15453-003	1.278,20

10453
15453

Suporte de Plástico

6

Pcs

Cu-Be

Al-Br

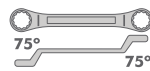

• 8x9 • 10x11 • 12x13 • 14x15 • 16x17 • 18x19

Cu-Be

Al-Br

Part N°	€	Part N°	€
10453-016	498,98	15453-016	452,19

Cu-Be / Al-Br

Chaves de Cachimbo, Ajustáveis e Articuladas Anti-faísca



10462
15462

Chave de Cachimbo

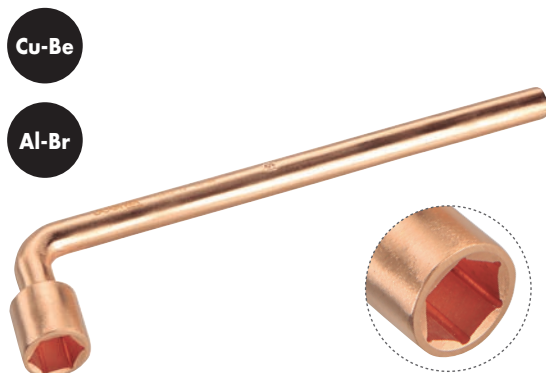

Cu-Be

Al-Br

mm	Cu-Be			Al-Br		
	L mm	L2 mm	Part N°	€	Part N°	€
13	240	45	10462-13	123,43	15462-13	94,94
17	245	45	10462-17	176,32	15462-17	135,63
19	250	48	10462-19	185,13	15462-19	142,40
22	278	59	10462-22	246,84	15462-22	189,88
24	286	63	10462-24	264,48	15462-24	203,46
27	294	69	10462-27	282,10	15462-27	217,00
30	302	75	10462-30	317,36	15462-30	244,14
32	310	81	10462-32	352,65	15462-32	271,27
36	330	85	10462-36	405,53	15462-36	311,94
41	350	90	10462-41	493,69	15462-41	379,77

10493
15493

Chave Ajustável Profissional Moleta Central

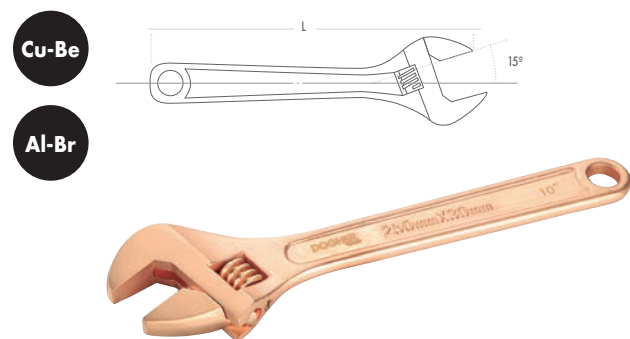

Cu-Be

Al-Br

L mm	L "	mm	Cu-Be		Al-Br	
			Part N°	€	Part N°	€
150	6	18	10493-150	205,58	15493-150	135,49
200	8	24	10493-200	214,12	15493-200	132,42
250	10	30	10493-250	285,50	15493-250	187,08
300	12	36	10493-300	317,19	15493-300	238,27
375	15	46	10493-375	484,85	15493-375	374,75
450	18	55	10493-450	658,57	15493-450	531,15
600	24	65	10493-600	1.215,93	15493-600	910,62
900	36	70	10493-900	2.702,09	15493-900	1.869,40

10471
15471

Chave Articulada de Pivô Fixo



Cu-Be

Al-Br

mm	L mm	Cu-Be		Al-Br	
		Part N°	€	Part N°	€
32~75	205	10471-32-75	211,07	15471-32-75	156,35
50~120	288	10471-50-120	331,14	15471-50-120	245,29
115~170	310	10471-115-170	556,11	15471-115-170	411,95

10484
15484

Chave de Luneta Grande Esforço

Cu-Be

Al-Br



mm	L mm	Cu-Be		Al-Br	
		Part N°	€	Part N°	€
24	180	10484-24	434,75	15484-24	322,05
27	190	10484-27	434,75	15484-27	322,05
30	200	10484-30	434,75	15484-30	322,05
32	235	10484-32	434,75	15484-32	322,05
36	245	10484-36	461,92	15484-36	342,16
41	265	10484-41	473,01	15484-41	350,39
46	280	10484-46	522,42	15484-46	386,98
50	290	10484-50	634,85	15484-50	470,25
55	300	10484-55	747,94	15484-55	554,02

10484
15484

Extensão para Chave de Luneta Grande Esforço

Cu-Be

Al-Br



L mm	Cu-Be		Al-Br	
	Part N°	€	Part N°	€
460	10484-001	319,76	15484-001	236,86
610	10484-002	420,91	15484-002	311,78
760	10484-003	516,32	15484-003	382,46

Cu-Be / Al-Br

Chaves de Pancada Anti-faísca



10478
15478

Chave de Boca Aberta de Pancada

Cu-Be

Al-Br

DIN133



		Cu-Be		Al-Br	
A mm	L mm	Part N°	€	Part N°	€
17	125	10478-17	122,07	15478-17	90,35
19	125	10478-19	126,54	15478-19	93,95
22	135	10478-22	131,69	15478-22	97,57
24	150	10478-24	141,18	15478-24	104,79
25	150	10478-25	158,84	15478-25	117,46
27	175	10478-27	160,39	15478-27	118,57
28	175	10478-28	161,72	15478-28	119,70
29	190	10478-29	167,50	15478-29	144,54
30	190	10478-30	193,94	15478-30	145,92
32	190	10478-32	193,94	15478-32	153,59
33	200	10478-33	193,94	15478-33	162,62
34	200	10478-34	193,94	15478-34	164,17
35	210	10478-35	232,23	15478-35	171,66
36	200	10478-36	234,29	15478-36	173,30
37	220	10478-37	256,02	15478-37	189,72
38	220	10478-38	255,66	15478-38	191,52
41	230	10478-41	281,09	15478-41	207,80
42	230	10478-42	329,60	15478-42	243,52
45	250	10478-45	354,97	15478-45	262,00
46	250	10478-46	358,07	15478-46	264,50
47	250	10478-47	384,71	15478-47	284,60
50	275	10478-50	415,19	15478-50	307,18
52	275	10478-52	431,98	15478-52	337,89
54	305	10478-54	431,98	15478-54	352,36

		Cu-Be		Al-Br	
A mm	L mm	Part N°	€	Part N°	€
55	305	10478-55	476,33	15478-55	352,36
56	305	10478-56	493,69	15478-56	369,13
58	315	10478-58	493,69	15478-58	442,67
60	315	10478-60	604,47	15478-60	446,90
63	335	10478-63	634,76	15478-63	474,14
65	335	10478-65	659,85	15478-65	487,86
67	335	10478-67	705,29	15478-67	580,77
70	370	10478-70	867,77	15478-70	641,46
71	370	10478-71	910,18	15478-71	671,99
75	375	10478-75	934,49	15478-75	722,33
77	375	10478-77	1.057,93	15478-77	806,43
80	400	10478-80	1.057,93	15478-80	851,81
82	400	10478-82	1.059,56	15478-82	934,07
85	400	10478-85	1.066,74	15478-85	970,56
88	445	10478-88	1.234,24	15478-88	1.099,60
90	445	10478-90	1.269,52	15478-90	1.164,02
94	445	10478-94	1.410,58	15478-94	1.259,65
95	445	10478-95	1.445,71	15478-95	1.291,14
100	485	10478-100	1.939,44	15478-100	1.522,57
105	485	10478-105	2.292,07	15478-105	1.852,29
110	513	10478-110	2.468,46	15478-110	1.929,87
115	513	10478-115	2.644,82	15478-115	2.312,49
120	530	10478-120	2.821,06	15478-120	2.473,47

10452
15452

Chave de Luneta de Pancada

Cu-Be

Al-Br

DIN133



		Cu-Be		Al-Br				Cu-Be		Al-Br	
mm	L mm	Part N°	€	Part N°	€	mm	L mm	Part N°	€	Part N°	€
17	145	10452-17	123,04	15452-17	98,46	60	274	10452-60	525,15	15452-60	411,74
19	145	10452-19	126,32	15452-19	100,24	61	274	10452-61	543,65	15452-61	427,11
20	155	10452-20	129,61	15452-20	101,15	62	274	10452-62	556,27	15452-62	435,73
22	155	10452-22	132,89	15452-22	102,04	63	298	10452-63	573,85	15452-63	449,38
24	165	10452-24	136,16	15452-24	103,83	64	298	10452-64	590,95	15452-64	462,97
25	165	10452-25	154,80	15452-25	121,20	65	298	10452-65	592,03	15452-65	450,35
26	175	10452-26	154,97	15452-26	121,25	66	298	10452-66	597,98	15452-66	469,10
27	175	10452-27	154,97	15452-27	121,25	67	320	10452-67	608,21	15452-67	476,62
28	175	10452-28	162,03	15452-28	127,22	68	320	10452-68	732,74	15452-68	575,43
29	185	10452-29	166,09	15452-29	130,05	69	320	10452-69	734,61	15452-69	575,43
30	185	10452-30	172,40	15452-30	135,10	70	320	10452-70	735,83	15452-70	575,43
31	185	10452-31	178,40	15452-31	139,40	71	320	10452-71	739,16	15452-71	579,55
32	185	10452-32	180,73	15452-32	141,71	72	320	10452-72	745,52	15452-72	583,65
33	200	10452-33	196,86	15452-33	155,48	73	326	10452-73	751,33	15452-73	587,75
34	200	10452-34	205,07	15452-34	164,42	74	326	10452-74	755,36	15452-74	591,86
35	205	10452-35	215,31	15452-35	168,71	75	326	10452-75	759,76	15452-75	595,96
36	205	10452-36	218,59	15452-36	171,57	76	326	10452-76	797,40	15452-76	625,17
37	215	10452-37	239,64	15452-37	195,46	77	326	10452-77	806,73	15452-77	632,98
38	215	10452-38	259,48	15452-38	203,71	78	350	10452-78	830,89	15452-78	651,45
39	215	10452-39	303,04	15452-39	246,28	79	350	10452-79	854,87	15452-79	669,95
40	225	10452-40	319,92	15452-40	250,90	80	350	10452-80	877,41	15452-80	688,43
41	225	10452-41	326,07	15452-41	255,10	81	350	10452-81	927,55	15452-81	726,97
42	225	10452-42	354,22	15452-42	277,42	82	350	10452-82	939,74	15452-82	735,55
43	225	10452-43	363,53	15452-43	284,67	83	355	10452-83	950,45	15452-83	744,11
44	235	10452-44	365,10	15452-44	277,42	84	355	10452-84	962,15	15452-84	752,69
45	235	10452-45	365,81	15452-45	282,25	85	355	10452-85	972,69	15452-85	761,28
46	235	10452-46	369,26	15452-46	289,49	86	355	10452-86	1.066,34	15452-86	843,30
47	235	10452-47	399,76	15452-47	313,39	87	355	10452-87	1.082,75	15452-87	861,88
48	250	10452-48	406,59	15452-48	318,84	88	380	10452-88	1.124,79	15452-88	880,46
49	250	10452-49	413,54	15452-49	324,31	89	380	10452-89	1.148,25	15452-89	899,05
50	250	10452-50	421,54	15452-50	329,74	90	380	10452-90	1.164,77	15452-90	847,06
51	250	10452-51	432,03	15452-51	337,94	92	380	10452-92	1.197,57	15452-92	965,00
52	250	10452-52	441,79	15452-52	346,25	94	390	10452-94	1.213,98	15452-94	977,04
53	265	10452-53	445,99	15452-53	349,02	95	390	10452-95	1.260,14	15452-95	989,12
54	265	10452-54	449,09	15452-54	351,79	98	410	10452-98	1.394,43	15452-98	1.137,08
55	265	10452-55	452,49	15452-55	354,56	100	410	10452-100	1.443,58	15452-100	1.159,24
56	265	10452-56	492,58	15452-56	386,00	105	420	10452-105	1.476,43	15452-105	1.184,78
57	265	10452-57	501,28	15452-57	392,44	110	445	10452-110	1.839,61	15452-110	1.386,99
58	274	10452-58	508,00	15452-58	398,87	115	450	10452-115	2.296,60	15452-115	1.541,86
59	274	10452-59	517,10	15452-59	405,31	120	480	10452-120	2.363,27	15452-120	1.779,09

Cu-Be / Al-Br

Chaves de Pancada Anti-faísca



10452
15452

Chave de Luneta de Pancada

Cu-Be

Al-Br

DIN7444



SAE	Cu-Be			Al-Br		
"	L mm	Part N°	€	Part N°	€	
5/8	145	10452-5/8	125,20	15452-5/8	94,65	
11/16	145	10452-11/16	139,45	15452-11/16	106,00	
3/4	145	10452-3/4	147,64	15452-3/4	111,69	
25/32	145	10452-25/32	117,84	15452-25/32	107,05	
13/16	155	10452-13/16	134,12	15452-13/16	115,03	
7/8	155	10452-7/8	155,84	15452-7/8	118,71	
15/16	165	10452-15/16	162,93	15452-15/16	120,72	
1	175	10452-1	164,04	15452-1	122,68	
1.1/16	175	10452-1.1/16	164,04	15452-1.1/16	126,64	
1.1/8	185	10452-1.1/8	172,25	15452-1.1/8	130,62	
1.3/16	185	10452-1.3/16	180,45	15452-1.3/16	134,39	
1.1/4	185	10452-1.1/4	180,45	15452-1.1/4	148,41	
1.5/16	200	10452-1.5/16	202,02	15452-1.5/16	152,38	
1.3/8	200	10452-1.3/8	208,13	15452-1.3/8	156,33	
1.13/32	205	10452-1.13/32	262,48	15452-1.13/32	197,46	
1.7/16	205	10452-1.7/16	262,48	15452-1.7/16	209,08	
1.1/2	215	10452-1.1/2	278,88	15452-1.1/2	212,17	
1.9/16	225	10452-1.9/16	292,62	15452-1.9/16	220,71	
1.5/8	225	10452-1.5/8	312,19	15452-1.5/8	235,74	
1.11/16	225	10452-1.11/16	352,71	15452-1.11/16	241,65	
1.3/4	235	10452-1.3/4	360,91	15452-1.3/4	247,53	
1.13/16	235	10452-1.13/16	376,96	15452-1.13/16	278,19	
1.7/8	235	10452-1.7/8	392,56	15452-1.7/8	296,34	
1.15/16	250	10452-1.15/16	415,26	15452-1.15/16	305,95	
2	250	10452-2	418,17	15452-2	315,60	
2.1/16	265	10452-2.1/16	459,33	15452-2.1/16	334,85	
2.1/8	265	10452-2.1/8	475,74	15452-2.1/8	354,13	
2.3/16	265	10452-2.3/16	492,16	15452-2.3/16	373,43	
2.13/64	265	10452-2.13/64	492,16	15452-2.13/64	373,43	
2.1/4	274	10452-2.1/4	508,56	15452-2.1/4	386,79	

SAE	Cu-Be			Al-Br		
mm	L mm	Part N°	€	Part N°	€	
2.5/16	274	10452-2.5/16	508,56	15452-2.5/16	429,79	
2.3/8	274	10452-2.3/8	524,97	15452-2.3/8	441,39	
2.7/16	274	10452-2.7/16	524,97	15452-2.7/16	447,22	
2.1/2	298	10452-2.1/2	541,36	15452-2.1/2	453,01	
2.9/16	298	10452-2.9/16	588,03	15452-2.9/16	435,37	
2.5/8	298	10452-2.5/8	639,81	15452-2.5/8	474,94	
2.3/4	320	10452-2.3/4	689,01	15452-2.3/4	593,68	
2.13/16	320	10452-2.13/16	762,85	15452-2.13/16	633,26	
2.7/8	326	10452-2.7/8	892,97	15452-2.7/8	660,79	
2.15/16	326	10452-2.15/16	803,85	15452-2.15/16	671,79	
3	326	10452-3	853,07	15452-3	681,44	
3.1/16	350	10452-3.1/16	918,69	15452-3.1/16	722,77	
3.1/8	350	10452-3.1/8	951,50	15452-3.1/8	743,41	
3.1/4	355	10452-3.1/4	984,30	15452-3.1/4	764,04	
3.3/8	355	10452-3.3/8	1.017,11	15452-3.3/8	783,14	
3.1/2	380	10452-3.1/2	1.097,72	15452-3.1/2	810,50	
3.9/16	380	10452-3.9/16	1.148,36	15452-3.9/16	856,98	
3.5/8	390	10452-3.5/8	1.246,79	15452-3.5/8	969,77	
3.3/4	390	10452-3.3/4	1.312,42	15452-3.3/4	1.011,16	
3.7/8	410	10452-3.7/8	1.541,96	15452-3.7/8	1.092,04	
3.15/16	410	10452-3.15/16	1.607,64	15452-3.15/16	1.179,39	
4	410	10452-4	1.755,30	15452-4	1.226,59	
4.1/8	420	10452-4.1/8	1.804,54	15452-4.1/8	1.273,77	
4.1/4	445	10452-4.1/4	1.968,61	15452-4.1/4	1.481,49	
4.5/16	445	10452-4.5/16	2.132,68	15452-4.5/16	1.518,50	
4.1/2	450	10452-4.1/2	3.050,08	15452-4.1/2	1.812,05	
4.9/16	450	10452-4.9/16	2.460,65	15452-4.9/16	1.834,41	
4.11/16	480	10452-4.11/16	2.788,79	15452-4.11/16	1.945,66	
4.7/8	480	10452-4.7/8	3.116,91	15452-4.7/8	2.174,55	
4.15/16	480	10452-4.15/16	3.280,97	15452-4.15/16	2.394,11	

10531
15531

Sextavada

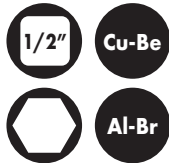

Cu-Be Al-Br

mm	L mm	Part N°	€	Part N°	€
6	40	10531-06	82,59	15531-06	70,13
7	40	10531-07	84,54	15531-07	71,95
8	40	10531-08	86,82	15531-08	73,65
9	40	10531-09	88,56	15531-09	75,45
10	40	10531-10	82,09	15531-10	77,16
11	40	10531-11	86,32	15531-11	78,91
12	40	10531-12	92,00	15531-12	80,67
13	40	10531-13	96,24	15531-13	82,41
14	40	10531-14	97,67	15531-14	84,19
15	40	10531-15	100,50	15531-15	85,98
16	40	10531-16	104,02	15531-16	87,69
17	40	10531-17	102,38	15531-17	94,69
18	42	10531-18	110,39	15531-18	96,42
19	42	10531-19	115,35	15531-19	98,20
20	42	10531-20	116,78	15531-20	99,95
21	43	10531-21	120,30	15531-21	105,21
22	43	10531-22	124,54	15531-22	108,73
23	43	10531-23	131,82	15531-23	112,23
24	43	10531-24	140,05	15531-24	119,24
25	43	10531-25	157,10	15531-25	122,75
26	43	10531-26	168,43	15531-26	131,52
27	46	10531-27	176,91	15531-27	136,78
28	46	10531-28	186,83	15531-28	140,29
29	46	10531-29	201,25	15531-29	153,18
30	46	10531-30	208,06	15531-30	154,32
32	46	10531-32	228,59	15531-32	157,93

10530
15530

12 Faces

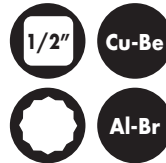

Cu-Be Al-Br

mm	L mm	Part N°	€	Part N°	€
6	40	10530-06	82,59	15530-06	67,16
7	40	10530-07	84,54	15530-07	68,73
8	40	10530-08	86,82	15530-08	70,60
9	40	10530-09	88,56	15530-09	72,01
10	40	10530-10	82,09	15530-10	66,74
11	40	10530-11	86,32	15530-11	70,17
12	40	10530-12	92,00	15530-12	74,80
13	40	10530-13	96,24	15530-13	78,26
14	40	10530-14	97,67	15530-14	79,40
15	40	10530-15	100,50	15530-15	81,70
16	40	10530-16	104,02	15530-16	84,58
17	40	10530-17	102,38	15530-17	83,23
18	42	10530-18	110,39	15530-18	89,75
19	42	10530-19	115,35	15530-19	93,79
20	42	10530-20	116,78	15530-20	94,94
21	43	10530-21	120,30	15530-21	97,81
22	43	10530-22	124,54	15530-22	101,25
23	43	10530-23	131,82	15530-23	107,16
24	43	10530-24	140,05	15530-24	113,85
25	43	10530-25	157,10	15530-25	127,72
26	43	10530-26	168,43	15530-26	136,94
27	46	10530-27	176,91	15530-27	143,83
28	46	10530-28	186,83	15530-28	151,89
29	46	10530-29	201,25	15530-29	163,62
30	46	10530-30	208,06	15530-30	169,16
32	46	10530-32	228,59	15530-32	185,85

10544
15544

Roquete



Lmm	Cu-Be		Al-Br	
	Part N°	€	Part N°	€
245	10544-001	293,76	15544-001	273,49

Cu-Be / Al-Br

1/2"

Acessórios para Chaves de Caixa Anti-faixa



10543
15543

Articulação Universal

1/2"

Cu-Be

Al-Br



Cu-Be

Al-Br

Part N°	€	Part N°	€
10543-009	257,75	15543-009	162,84

10543
15543

Adaptador Ampliador

1/2"

3/4"

Cu-Be

Al-Br



Cu-Be

Al-Br

□	□	Part N°	€	Part N°	€
1/2"	3/4"	10543-011	203,33	15543-011	137,40

10543
15543

Cabo Corrediço em "T" com Tope Lateral

1/2"

Cu-Be

Al-Br

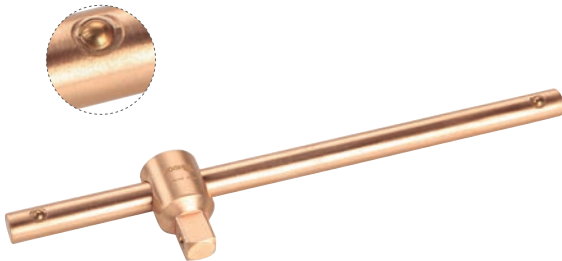

Cu-Be

Al-Br

□	L mm	Part N°	€	Part N°	€
1/2"	250	10543-025	200,29	15543-025	196,91

10543
15543

Extensor

1/2"

Cu-Be

Al-Br



Cu-Be

Al-Br

L mm	Part N°	€	Part N°	€
100	10543-100	173,59	15543-100	133,23
200	10543-200	192,28	15543-200	146,30
250	10543-250	186,94	15543-250	160,69

10543
15543

Berbiqui

1/2"

Cu-Be

Al-Br

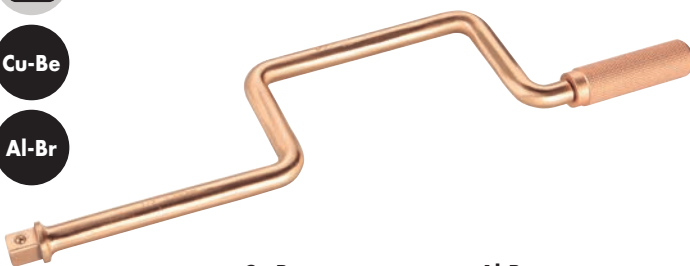

Cu-Be

Al-Br

L mm	H mm	Part N°	€	Part N°	€
390	96	10543-400	390,03	15543-400	268,02

10465
15465

Chave de Roda

1/2"

Cu-Be

Al-Br



Cu-Be

Al-Br

□	L mm	L2 mm	Part N°	€	Part N°	€
1/2"	230	60	10465-1/2-225	252,05	15465-1/2-225	201,64

10549
15549

Sextavada

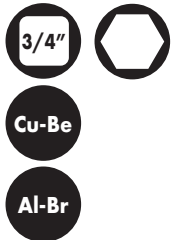

Cu-Be

Al-Br

	Cu-Be			Al-Br		
Icon	L mm	Part N°	€	Part N°	€	
17	50	10549-17	137,67	15549-17	113,25	
18	50	10549-18	169,82	15549-18	113,61	
19	50	10549-19	138,27	15549-19	113,95	
21	55	10549-21	152,25	15549-21	125,32	
22	55	10549-22	155,93	15549-22	126,64	
23	55	10549-23	171,12	15549-23	133,81	
24	55	10549-24	175,08	15549-24	142,75	
26	55	10549-26	182,18	15549-26	144,27	
27	55	10549-27	185,36	15549-27	153,05	
28	55	10549-28	196,71	15549-28	160,69	
29	55	10549-29	238,33	15549-29	171,82	
30	60	10549-30	252,77	15549-30	181,21	
32	60	10549-32	284,97	15549-32	204,66	
34	60	10549-34	306,63	15549-34	221,08	
36	60	10549-36	329,43	15549-36	235,74	
38	60	10549-38	351,66	15549-38	252,16	
41	65	10549-41	386,64	15549-41	277,97	
46	65	10549-46	457,21	15549-46	328,39	
50	70	10549-50	501,08	15549-50	360,06	

10548
15548

12 Faces

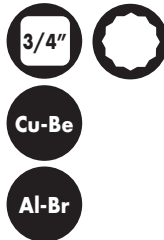

Cu-Be

Al-Br

	Cu-Be			Al-Br		
Icon	L mm	Part N°	€	Part N°	€	
17	50	10548-17	137,67	15548-17	113,25	
18	50	10548-18	169,82	15548-18	113,61	
19	50	10548-19	138,27	15548-19	113,95	
21	55	10548-21	152,25	15548-21	125,32	
22	55	10548-22	155,93	15548-22	126,64	
23	55	10548-23	171,12	15548-23	133,81	
24	55	10548-24	175,08	15548-24	142,75	
26	55	10548-26	182,18	15548-26	144,27	
27	55	10548-27	185,36	15548-27	153,05	
28	55	10548-28	196,71	15548-28	160,69	
29	55	10548-29	238,33	15548-29	171,82	
30	60	10548-30	252,77	15548-30	181,21	
32	60	10548-32	284,97	15548-32	204,66	
34	60	10548-34	306,63	15548-34	221,08	
36	60	10548-36	329,43	15548-36	235,74	
38	60	10548-38	351,66	15548-38	252,16	
41	65	10548-41	386,64	15548-41	277,97	
46	65	10548-46	457,21	15548-46	328,39	
50	70	10548-50	501,08	15548-50	360,06	

10554
15554

Roquete



Cu-Be

Al-Br

Lmm	Part N°	€	Part N°	€
320	10554-001	587,51	15554-001	549,97

Cu-Be / Al-Br

3/4"

Accesorios para Chaves de Caixa Anti-faisca



10553
15553

Articulação Universal

- 3/4"
- Cu-Be
- Al-Br



Cu-Be		Al-Br	
Part N°	€	Part N°	€
10553-009	534,09	15553-009	410,83

10553
15553

Adaptador Ampliador

- 3/4"
- 1"
- Cu-Be
- Al-Br



Cu-Be		Al-Br		
Part N°	€	Part N°	€	
3/4"	10553-011	413,49	15553-011	280,34
1"	15553-011	280,34		

10553
15553

Adaptador Redutor

- 3/4"
- 1/2"
- Cu-Be
- Al-Br



Cu-Be		Al-Br		
Part N°	€	Part N°	€	
3/4"	10553-012	245,44	15553-012	167,61
1/2"	15553-012	167,61		

10553
15553

Cabo Corrediço em "T" com Tope Lateral

- 3/4"
- Cu-Be
- Al-Br

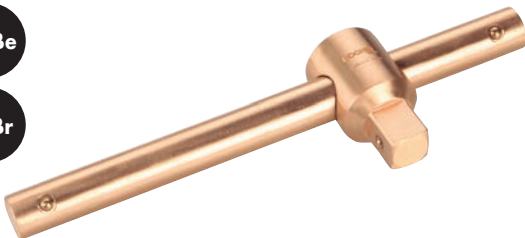

Cu-Be		Al-Br			
L mm	Part N°	€	Part N°	€	
3/4"	450	10553-014	307,09	15553-014	236,23

10553
15553

Extensor

- 3/4"
- Cu-Be
- Al-Br

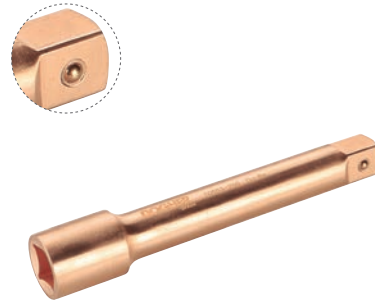

Cu-Be		Al-Br		
L mm	Part N°	€	Part N°	€
200	10553-200	269,71	15553-200	219,45

10558
15558

Sextavada



Cu-Be

Al-Br



10557
15557

12 Faces



Cu-Be

Al-Br



Hexagon	Cu-Be			Al-Br		
	L mm	Part N°	€	Part N°	€	
22	55	10558-22	195,66	15558-22	141,41	
24	55	10558-24	226,54	15558-24	156,16	
26	55	10558-26	247,14	15558-26	193,01	
27	55	10558-27	267,75	15558-27	199,70	
28	55	10558-28	264,31	15558-28	203,74	
29	55	10558-29	308,91	15558-29	208,44	
30	60	10558-30	329,50	15558-30	213,12	
31	60	10558-31	310,62	15558-31	230,55	
32	60	10558-32	348,04	15558-32	246,62	
34	60	10558-34	411,87	15558-34	260,03	
36	65	10558-36	432,47	15558-36	278,82	
38	65	10558-38	453,08	15558-38	300,25	
41	70	10558-41	463,38	15558-41	341,12	
46	75	10558-46	504,56	15558-46	379,33	
50	75	10558-50	535,44	15558-50	416,84	
55	80	10558-55	586,95	15558-55	470,47	
60	85	10558-60	731,10	15558-60	525,43	
65	90	10558-65	782,59	15558-65	583,07	
70	90	10558-70	864,97	15558-70	642,03	
75	95	10558-75	1.027,67	15558-75	701,02	
80	95	10558-80	1.091,50	15558-80	762,02	

Hexagon	Cu-Be			Al-Br		
	L mm	Part N°	€	Part N°	€	
22	55	10557-22	195,66	15557-22	155,28	
24	55	10557-24	226,54	15557-24	179,78	
26	55	10557-26	247,14	15557-26	196,14	
27	55	10557-27	267,75	15557-27	212,49	
28	55	10557-28	264,31	15557-28	209,76	
29	55	10557-29	308,91	15557-29	245,16	
30	60	10557-30	329,50	15557-30	261,50	
31	60	10557-31	310,62	15557-31	246,52	
32	60	10557-32	348,04	15557-32	276,23	
34	60	10557-34	411,87	15557-34	326,89	
36	65	10557-36	432,47	15557-36	343,23	
38	65	10557-38	453,08	15557-38	359,58	
41	70	10557-41	463,38	15557-41	367,76	
46	75	10557-46	504,56	15557-46	400,45	
50	75	10557-50	535,44	15557-50	424,96	
55	80	10557-55	586,95	15557-55	465,83	
60	85	10557-60	731,10	15557-60	580,25	
65	90	10557-65	782,59	15557-65	621,11	
70	90	10557-70	864,97	15557-70	686,49	
75	95	10557-75	1.027,67	15557-75	815,62	
80	95	10557-80	1.091,50	15557-80	866,27	

10560
15560

Roquete



Cu-Be



Lmm	Cu-Be		Al-Br	
	Part N°	€	Part N°	€
550	10560-001	1.228,42	15560-001	1.066,85

Cu-Be / Al-Br

1"

Accesorios para Chaves de Caixa Anti-faisca



10559
15559

Articulação Universal

- 1"
- Cu-Be
- Al-Br



Cu-Be Al-Br

Part N°	€	Part N°	€
10559-003	813,28	15559-003	536,81

10559
15559

Adaptador Redutor

- 1"
- 3/4"
- Cu-Be
- Al-Br

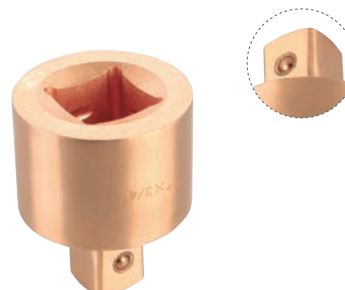

Cu-Be Al-Br

		Part N°	€	Part N°	€
		10559-012	400,25	15559-012	272,22

10559
15559

Extensor

- 1"
- Cu-Be
- Al-Br

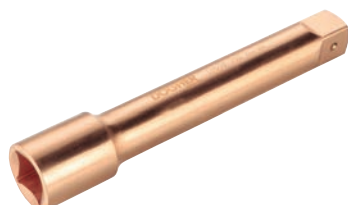

Cu-Be Al-Br

L mm	Part N°	€	Part N°	€
250	10559-250	561,70	15559-250	378,84

10559
15559

Cabo Corrediço em "T"

- 1"
- Cu-Be
- Al-Br

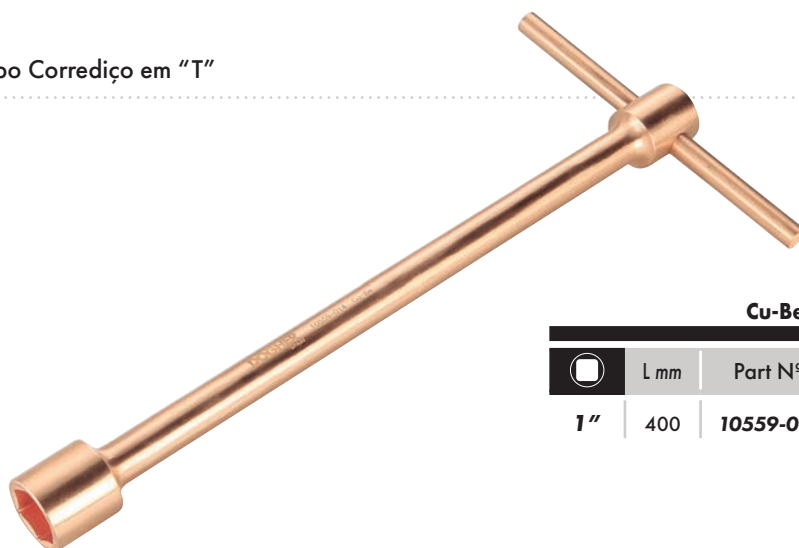

Cu-Be Al-Br

	L mm	Part N°	€	Part N°	€
1"	400	10559-014	560,82	15559-014	527,38

10600
15600

Sextavada Curta

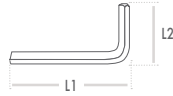

Cu-Be

Al-Br



mm	Cu-Be		Al-Br			
	L1 mm	L2 mm	Part N°	€	Part N°	€
1,5	38	13	10600-01,5	57,56	15600-01,5	36,00
2	38	13	10600-02	58,51	15600-02	36,00
3	59	25	10600-03	59,20	15600-03	36,45
4	65	30	10600-04	60,14	15600-04	37,00
5	79	32	10600-05	62,75	15600-05	38,62
6	85	37	10600-06	65,44	15600-06	40,27
7	88	43	10600-07	72,45	15600-07	44,59
8	92	44	10600-08	76,02	15600-08	46,79
9	97	44	10600-09	83,99	15600-09	51,69
10	110	45	10600-10	90,17	15600-10	55,51
12	130	52	10600-12	174,04	15600-12	69,96

10650
15650

Chave para Tubo Profissional

Cu-Be

Al-Br

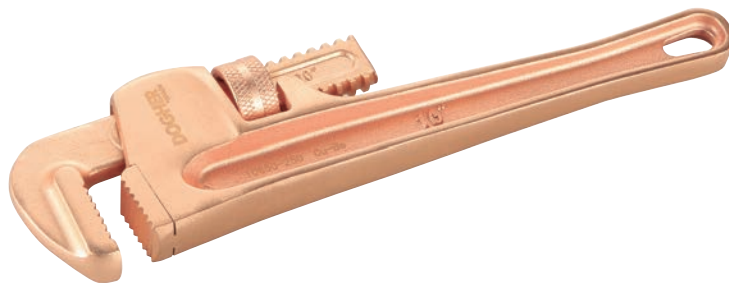
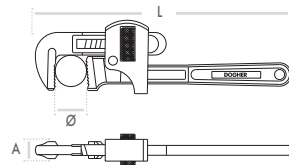

L mm	Ø mm	Cu-Be		Al-Br	
		Part N°	€	Part N°	€
200	25	10650-200	415,20	15650-200	306,75
250	30	10650-250	481,30	15650-250	356,21
300	40	10650-300	523,31	15650-300	385,92
350	50	10650-350	614,51	15650-350	455,16
450	60	10650-450	782,64	15650-450	578,18
600	75	10650-600	1.154,80	15650-600	852,84
900	85	10650-900	1.985,98	15650-900	1.469,77
1200	110	10650-1200	3.618,25	15650-1200	2.677,76

Cu-Be / Al-Br

Chaves para Valvulas Anti-faisca



10680
15680

Chave para Rodas de Valvulas

Cu-Be

Al-Br



Cu-Be				Al-Br		
B mm	Ø mm	L mm	Part N°	€	Part N°	€
60	36	370	10680-370	465,48	15680-370	264,45

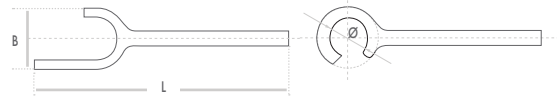

10685
15685

Chave de Tampar

Cu-Be

Al-Br



Cu-Be				Al-Br		
L mm	S1 mm	S2 mm	Part N°	€	Part N°	€
300	38	52	10685-300	286,36	15685-300	221,25

10681
15681

Chave para Valvulas

Cu-Be

Al-Br

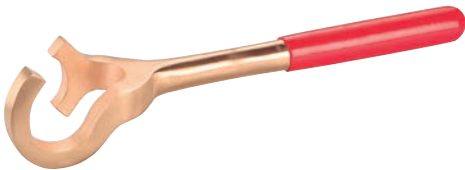

Cu-Be				Al-Br			
L mm	L"	B mm	Ø mm	Part N°	€	Part N°	€
210	8	62	23	10681-30	285,35	15681-30	270,95
215	8,5	57	32	10681-32	331,05	15681-32	306,02
290	11	58	36	10681-35	419,23	15681-35	398,09
400	16	83	46	10681-40	736,53	15681-40	699,38
485	19	100	48	10681-45	840,80	15681-45	798,39
800	31	114	58	10681-48	1.006,05	15681-48	955,32

10690
15690

Gancho Girador Valvulas

Cu-Be

Al-Br

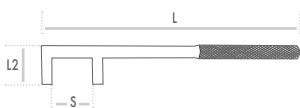

Cu-Be				Al-Br			
S mm	L mm	L2 mm	Part N°	€	Part N°	€	
30	200	44	10690-30	246,82	15690-30	165,30	
32	300	50	10690-32	339,35	15690-32	224,95	
35	250	47	10690-35	274,67	15690-35	186,23	
40	300	50	10690-40	339,35	15690-40	224,95	
45	350	58	10690-45	413,99	15690-45	247,96	
48	375	62	10690-48	448,85	15690-48	273,07	
50	400	67	10690-50	476,70	15690-50	288,74	
55	450	73	10690-55	569,24	15690-55	300,26	
60	500	79	10690-60	613,06	15690-60	320,13	
65	550	82	10690-65	698,62	15690-65	358,86	
70	600	85	10690-70	767,31	15690-70	401,73	
75	650	88	10690-75	853,88	15690-75	448,84	
80	700	91	10690-80	971,32	15690-80	512,64	
85	750	97	10690-85	1.080,78	15690-85	577,52	
90	800	103	10690-90	1.192,24	15690-90	606,82	

10712
15712

Marreta Punho Madeira

Cu-Be

Al-Br



Cu-Be

Al-Br

g	L mm	Cu-Be		Al-Br	
		Part N°	€	Part N°	€
2000	400	10712-2000A	447,12	15712-2000A	357,76
2500	400	10712-2500A	557,73	15712-2500A	447,07
3000	700	10712-3000A	669,15	15712-3000A	536,38
4000	900	10712-4000A	887,76	15712-4000A	711,03

10713
15713

Marreta Punho Fibra de Vidro

Cu-Be

Al-Br



Pino de Segurança

Cu-Be

Al-Br

g	L mm	Cu-Be		Al-Br	
		Part N°	€	Part N°	€
1000	400	10713-1000A	255,79	15713-1000A	204,76
1500	400	10713-1500A	294,71	15713-1500A	236,10
2000	400	10713-2000A	360,59	15713-2000A	289,11
2500	700	10713-2500A	481,31	15713-2500A	385,47
3000	700	10713-3000A	571,99	15713-3000A	457,74
3500	700	10713-3500A	722,43	15713-3500A	578,18

10713
15713

Marreta Octogonal Punho Fibra de Vidro

Cu-Be

Al-Br



Pino de Segurança

Cu-Be

Al-Br

g	L mm	Cu-Be		Al-Br	
		Part N°	€	Part N°	€
450	310	10713-450	140,65	15713-450	103,43
1000	400	10713-1000	227,54	15713-1000	144,42
1500	400	10713-1500	300,41	15713-1500	192,55
2000	400	10713-2000	410,13	15713-2000	264,76
2500	700	10713-2500	475,74	15713-2500	336,97
3000	700	10713-3000	574,17	15713-3000	409,16
4500	900	10713-4500	803,85	15713-4500	541,54
5000	900	10713-5000	920,80	15713-5000	589,68
6800	900	10713-6800	1.164,77	15713-6800	818,33
8000	900	10713-8000	1.366,26	15713-8000	866,46
10000	900	10713-10000	1.804,54	15713-10000	1.442,91
12900	900	10713-12000	2.214,63	15713-12000	1.731,50

Cu-Be / Al-Br

Martelos Anti-faixa



10700
15700

Martelo de Bola Punho Madeira

Cu-Be

Al-Br



g	L mm	Cu-Be		Al-Br	
		Part N°	€	Part N°	€
300	280	10700-300	90,16	15700-300	72,28
450	310	10700-450	120,12	15700-450	96,37
700	340	10700-700	169,03	15700-700	135,51
900	350	10700-900	225,96	15700-900	180,67

10701
15701

Martelo de Bola Punho Fibra de Vidro

Cu-Be

Al-Br



Pino de Segurança

g	L mm	Cu-Be		Al-Br	
		Part N°	€	Part N°	€
300	280	10701-300	84,63	15701-300	73,37
450	310	10701-450	122,45	15701-450	97,82
700	340	10701-700	154,70	15701-700	123,90
900	350	10701-900	235,45	15701-900	188,54

10708
15708

Martelo Unha Curva

Cu-Be

Al-Br



Pino de Segurança

g	L mm	Cu-Be		Al-Br	
		Part N°	€	Part N°	€
500	300	10708-500	123,95	15708-500	91,69
700	330	10708-700	146,77	15708-700	108,35

10727
15727

Martelo Alemão

Cu-Be

Al-Br



Pino de Segurança

g	L mm	Cu-Be		Al-Br	
		Part N°	€	Part N°	€
255	280	10727-100	79,35	15727-100	73,37
355	280	10727-200	105,79	15727-200	84,30
455	280	10727-300	119,90	15727-300	103,57
500	310	10727-500	158,69	15727-500	130,10
800	340	10727-800	211,59	15727-800	168,63
1000	340	10727-1000	246,84	15727-1000	204,76
1500	400	10727-1500	335,01	15727-1500	277,05
2000	450	10727-2000	418,55	15727-2000	334,87

10720
15727

Picareta de Caldeireiro

Cu-Be

Al-Br



Pino de Segurança

g	L mm	Cu-Be		Al-Br	
		Part N°	€	Part N°	€
200	280	10720-200	105,83	15720-200	78,35
400	300	10720-400	133,00	15720-400	98,36
600	340	10720-600	146,59	15720-600	108,35
900	350	10720-900	207,17	15720-900	176,09

Cu-Be / Al-Br

Picaretas e Cunhas Anti-faisca



10719
15719

Picaretas Pá-Pico

Cu-Be

Al-Br

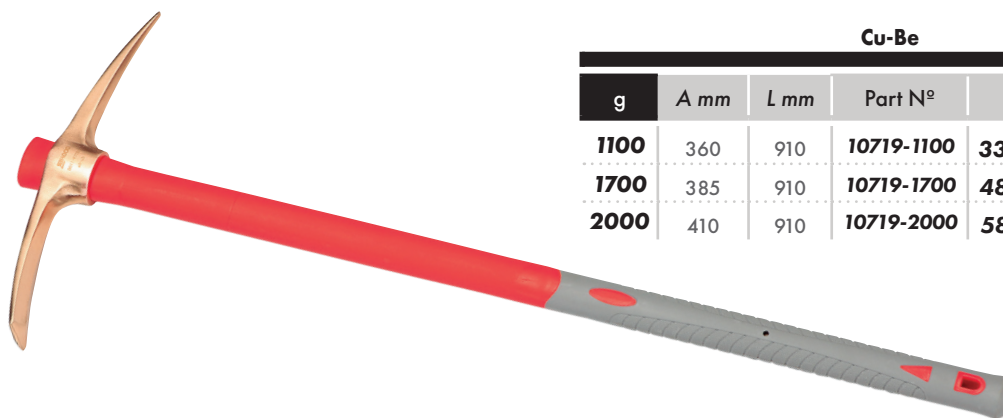

g	Cu-Be				Al-Br	
	A mm	L mm	Part N°	€	Part N°	€
1100	360	910	10719-1100	333,46	15719-1100	221,21
1700	385	910	10719-1700	486,95	15719-1700	323,40
2000	410	910	10719-2000	582,87	15719-2000	385,89

10726
15726

Cunha

Cu-Be

Al-Br

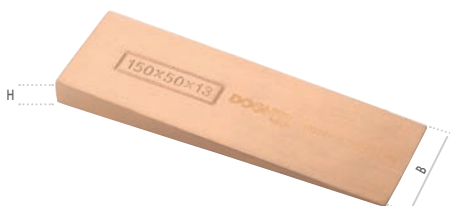

L mm	Cu-Be				Al-Br	
	B mm	H mm	Part N°	€	Part N°	€
80	13	6	10726-80-13	16,21	15726-80-13	13,01
100	50	10	10726-100-50	60,03	15726-100-50	48,17
135	50	18	10726-135-50	114,32	15726-135-50	91,55
150	25	8	10726-150-25	47,58	15726-150-25	43,37
150	30	13	10726-150-30	57,06	15726-150-30	46,14
150	40	8	10726-150-40	59,75	15726-150-40	48,17
150	50	13	10726-150-50	102,38	15726-150-50	81,91
180	13	6	10726-180-13	47,58	15726-180-13	44,03
180	32	13	10726-180-32	69,04	15726-180-32	55,41
180	50	19	10726-180-50	153,33	15726-180-50	122,86
200	20	30	10726-200-20	135,72	15726-200-20	108,41
200	30	30	10726-200-30	165,29	15726-200-30	132,49
200	40	40	10726-200-40	257,11	15726-200-40	180,85
200	50	12	10726-200-50	123,66	15726-200-50	105,11
230	40	20	10726-230-40	174,30	15726-230-40	139,73
250	40	30	10726-250-40	270,85	15726-250-40	216,81
300	50	40	10726-300-50	529,94	15726-300-50	424,01



10749
15749

Punção Sextavado

Cu-Be

Al-Br



Cu-Be

Al-Br

A mm	L mm	Part N°	€	Part N°	€
12	100	10749-100	56,09	15749-100	47,68
14	150	10749-150	87,21	15749-150	61,92

10746
15746

Saca-Troços Cilíndrico

Cu-Be

Al-Br

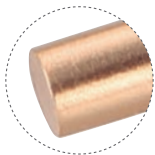

Cu-Be

Al-Br

Ø mm	Ø1 mm	L mm	Part N°	€	Part N°	€
2	9	110	10746-02	105,48	15746-02	78,13
3	9	110	10746-03	105,48	15746-03	78,13
4	10	110	10746-04	105,48	15746-04	78,13
5	10	110	10746-05	116,81	15746-05	96,13
6	12	115	10746-06	129,77	15746-06	96,13
8	14	120	10746-08	138,09	15746-08	102,28
10	14	120	10746-10	143,18	15746-10	130,02

10748
15748

Saca-Troços Cónico

Cu-Be

Al-Br

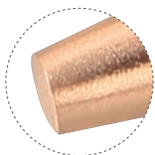

Cu-Be

Al-Br

A mm	L mm	Part N°	€	Part N°	€
18	200	10748-05	150,32	15748-05	111,34
20	250	10748-08	179,33	15748-08	132,85
20	300	10748-10	213,70	15748-10	158,29

10757
15757

Escopros Cortafriós

Cu-Be

Al-Br



Cu-Be

Al-Br

A mm	L mm	Part N°	€	Part N°	€
22	150	10757-150	106,14	15757-150	72,80
22	200	10757-200	136,61	15757-200	93,60
24	250	10757-250	184,36	15757-250	126,54
25	300	10757-300	219,44	15757-300	150,78
27	400	10757-400	282,80	15757-400	194,13

10761
15761

Escopros Octogonal

Cu-Be

Al-Br



Cu-Be

Al-Br

A mm	B mm	L mm	Part N°	€	Part N°	€
4	4	140	10761-150	152,06	15761-150	104,43
4	4	200	10761-200	243,52	15761-200	167,53
5	5	300	10761-300	398,54	15761-300	274,04

Cu-Be / Al-Br

Arcos e Folhas de Serra Anti-faisca



10840
15840

Arco de Serra

Cu-Be

Al-Br

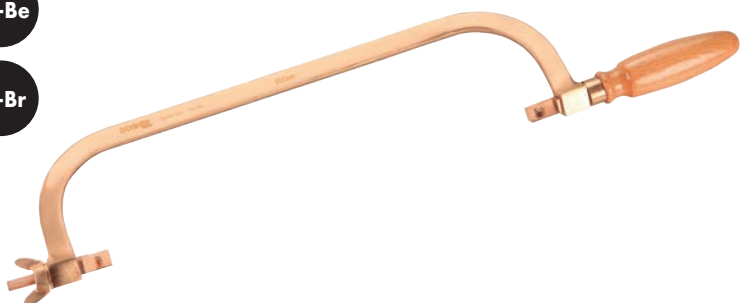

		Cu-Be		Al-Br	
L mm	Part N°	€	Part N°	€	
500	10840-001	709,03	15840-001	525,21	

10840
15840

Folha de Serra de Mão

Cu-Be

Al-Br

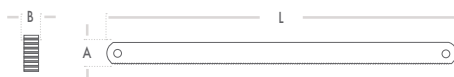

		Cu-Be		Al-Br	
L mm	A mm	Part N°	€	Part N°	€
300	12	10840-050	228,61	15840-050	169,34



10804
15804

Lima Chata de Grão Entrefino Punho Bimaterial

Cu-Be

Al-Br



Cu-Be

L mm	L"	A mm	B mm	Part N°	€
200	8	20	6	10804-200	156,09
300	12	31	8	10804-300	270,48

10805
15805

Lima Meia Cana de Grão Entrefino Punho Bimaterial

Cu-Be

Al-Br



Cu-Be

L mm	L"	A mm	B mm	Part N°	€
200	8	19	10	10805-200	154,83

10806
15806

Lima Triangular de Grão Entrefino Punho Bimaterial

Cu-Be

Al-Br

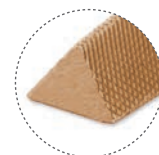

Cu-Be

L mm	L"	B mm	Part N°	€
200	8	7	10806-200	161,78

Cu-Be / Al-Br

Limas Anti-faisca



10807
15807

Lima Quadrada de Grão Entrefino Punho Bimaterial

Cu-Be

Al-Br



Cu-Be

L mm	L"	A mm	Part N°	€
200	10	10	10807-200	150,41

10808
15808

Lima Cana Redonda de Grão Entrefino Punho Bimaterial

Cu-Be

Al-Br



Cu-Be

L mm	L"	Ø mm	Part N°	€
200	8	6	10808-200	150,41

10892
15892

Chave para Andaimes

Cu-Be

Al-Br



mm	L mm	Cu-Be		Al-Br	
		Part N°	€	Part N°	€
10	230	10892-10	223,60	15892-10	165,63
11	240	10892-11	235,37	15892-11	174,35
12	250	10892-12	247,79	15892-12	183,55
13	260	10892-13	260,80	15892-13	193,19
14	270	10892-14	274,55	15892-14	203,37
16	300	10892-16	304,22	15892-16	225,35
17	310	10892-17	320,22	15892-17	237,20
18	320	10892-18	337,07	15892-18	249,69
19	330	10892-19	337,07	15892-19	249,69
20	340	10892-20	354,82	15892-20	262,84
22	350	10892-22	373,50	15892-22	276,65
24	370	10892-24	373,50	15892-24	276,65
27	400	10892-27	456,46	15892-27	338,11
30	430	10892-30	456,46	15892-30	338,11
32	430	10892-32	456,46	15892-32	338,11

10870
15870

Pá Redonda com Cabo de Madeira

Cu-Be

Al-Br



A mm	B mm	L mm	Cu-Be		Al-Br	
			Part N°	€	Part N°	€
240	420	1450	10870-010	520,33	15870-010	293,93

Cu-Be / Al-Br

Enxadas, Raspador e Barras de Desmoldar Ainti-faísca



10876
15876

Enxada com Cabo de Madeira

Cu-Be

Al-Br



		Cu-Be		Al-Br	
A mm	B mm	Part N°	€	Part N°	€
130	130	10876-130	594,94	15876-130	440,70
200	200	10876-200	901,59	15876-200	667,85

10850
15850

Raspador em Ângulo

Cu-Be

Al-Br



		Cu-Be		Al-Br	
A mm	L mm	Part N°	€	Part N°	€
45	300	10850-001	219,90	15850-001	170,36

10884
15884

Barra de Desmoldar

Cu-Be

Al-Br



		Cu-Be		Al-Br	
L mm	Ø mm	Part N°	€	Part N°	€
460	16	10884-460	345,20	15884-460	195,02
600	20	10884-600	543,52	15884-600	462,00
760	22	10884-760	700,14	15884-760	500,83
900	22	10884-900	929,82	15884-900	525,18

10850
15850

Raspador Plano

Cu-Be

Al-Br



			Cu-Be		Al-Br	
A mm	L mm	L1 mm	Part N°	€	Part N°	€
30	325	200	10850-010	219,50	15850-010	156,79

10850
15850

Raspador Folha Larga

Cu-Be

Al-Br



			Cu-Be		Al-Br	
A mm	L mm	L1 mm	Part N°	€	Part N°	€
100	720	115	10850-020	231,38	15850-020	158,92

10850
15850

Raspador com 3 Lados

Cu-Be

Al-Br



			Cu-Be		Al-Br	
A mm	L mm	L1 mm	Part N°	€	Part N°	€
26	400	300	10850-030	270,89	15850-030	208,37

Cu-Be / Al-Br

Raspador, Espatulas e Extratores Anti-faisca



10850
15850

Raspador Triangular

Cu-Be

Al-Br



		Cu-Be		Al-Br	
A mm	L mm	Part N°	€	Part N°	€
150	470	10850-040	576,00	15850-040	460,79

10878
15878

Espatula Flexivel

Cu-Be

Al-Br



		Cu-Be		Al-Br		
A mm	L mm	L1 mm	Part N°	€	Part N°	€
50	200	95	10878-50	146,19	15878-50	89,94
75	200	95	10878-75	224,32	15878-75	154,23

10903
15903

Extrator Reversível de 3 Pernas

Cu-Be

Al-Br



		Cu-Be		Al-Br		
A min	A max	L"	Part N°	€	Part N°	€
50	100	4"	10903-100	1.368,76	15903-100	1.094,14
60	150	6"	10903-150	1.512,87	15903-150	1.214,67
70	200	8"	10903-200	1.615,37	15903-200	1.297,84
80	350	14"	10903-350	2.742,39	15903-350	1.944,45