

# DOGHER

TOOLS

Making Solutions



476



491



477



492



482



493



483



495

496



484



486



488

## Utensili Vari

# 900

# Utensili Vari

Spaccadadi e Estrattore



901

Spaccadadi



mm	Part N°	€
3 ~ 12 mm	901-03-12	38,56
12 ~ 16 mm	901-12-16	45,02
16 ~ 22 mm	901-16-22	55,65



- Rimuove dadi bloccati senza danneggiare la filettatura.
- Collocare lo spaccadadi come indicato nel disegno per un uso corretto dell'utensile..

905

Estrattore a Inerzia di Massa per Perni Filettati con Prese M3-M4-M5-M6-M8-M10

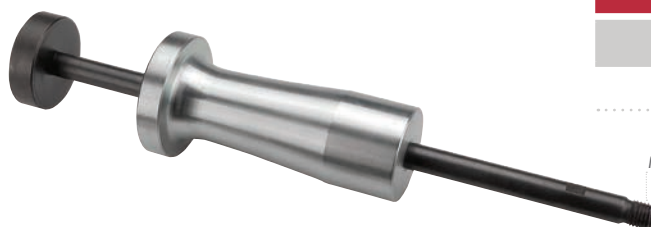

Part N°	€
905-150	157,25

M12x1,5

905

Bocche di Ricambio



Bocche	Part N°	€
M3	905-103	13,63
M4	905-104	13,63
M5	905-105	13,63
M6	905-106	13,63
M8	905-108	13,63
M10	905-110	13,63

**902**

Estrattori a 2 Bracci Reversibili per Esterni

Cr-V

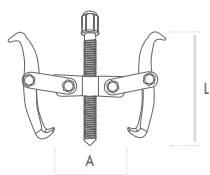

L mm	L"	A min-A max	Filetto	Tensione max.(KN)	Part N°	€
<b>75</b>	3"	15-80	Tr 12x2	11	<b>902-075</b>	<b>47,79</b>
<b>100</b>	4"	20-110	Tr 14x2,5	18	<b>902-100</b>	<b>56,26</b>
<b>150</b>	6"	25-160	Tr 17x2,5	30	<b>902-150</b>	<b>75,38</b>
<b>200</b>	8"	30-210	Tr 21x2,5	50	<b>902-200</b>	<b>137,43</b>
<b>300</b>	12"	50-310	Tr 30x4	98	<b>902-300</b>	<b>296,23</b>

**903**

Estrattori a 3 Bracci Reversibili per Esterni

Cr-V

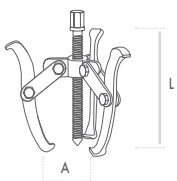

L mm	L"	A min-A max	Filetto	Tensione max.(KN)	Part N°	€
<b>75</b>	3"	15-80	Tr 12x2	16	<b>903-075</b>	<b>57,34</b>
<b>100</b>	4"	20-110	Tr 14x2,5	26	<b>903-100</b>	<b>67,52</b>
<b>150</b>	6"	25-160	Tr 17x2,5	44	<b>903-150</b>	<b>90,46</b>
<b>200</b>	8"	30-210	Tr 21x2,5	70	<b>903-200</b>	<b>164,92</b>
<b>300</b>	12"	50-310	Tr 30x4	110	<b>903-300</b>	<b>434,04</b>

**900/902/903**

Ricambi per Estrattori

L mm	L"	Bracci		Mandrino		Compatibile con	L mm	L"	Corpo		Compatibile con
		Part N°	€/u.	Part N°	€				Part N°	€	
<b>75</b>	3"	<b>900-075G</b>	<b>23,90</b>	<b>900-075H</b>	<b>14,33</b>	<b>902-075 / 903-075</b>	<b>75</b>	3"	<b>902-075C</b>	<b>9,56</b>	<b>902-075</b>
<b>100</b>	4"	<b>900-100G</b>	<b>28,13</b>	<b>900-100H</b>	<b>16,87</b>	<b>902-100 / 903-100</b>	<b>100</b>	4"	<b>902-100C</b>	<b>11,26</b>	<b>902-100</b>
<b>150</b>	6"	<b>900-150G</b>	<b>30,16</b>	<b>900-150H</b>	<b>22,62</b>	<b>902-150 / 903-150</b>	<b>150</b>	6"	<b>902-150C</b>	<b>15,08</b>	<b>902-150</b>
<b>200</b>	8"	<b>900-200G</b>	<b>48,10</b>	<b>900-200H</b>	<b>41,23</b>	<b>902-200 / 903-200</b>	<b>200</b>	8"	<b>902-200C</b>	<b>27,49</b>	<b>902-200</b>
<b>300</b>	12"	<b>900-300G</b>	<b>118,49</b>	<b>900-300H</b>	<b>59,24</b>	<b>902-300 / 903-300</b>	<b>300</b>	12"	<b>902-300C</b>	<b>53,32</b>	<b>902-300</b>

L mm	L"	Corpo		Compatibile con
		Part N°	€	
<b>75</b>	3"	<b>903-075C</b>	<b>11,47</b>	<b>903-075</b>
<b>100</b>	4"	<b>903-100C</b>	<b>13,50</b>	<b>903-100</b>
<b>150</b>	6"	<b>903-150C</b>	<b>18,09</b>	<b>903-150</b>
<b>200</b>	8"	<b>903-200C</b>	<b>32,98</b>	<b>903-200</b>
<b>300</b>	12"	<b>903-300C</b>	<b>86,80</b>	<b>903-300</b>

# Utensili Vari

Estrattori Meccanici



904

Estrattori a 2 Bracci Scorrevoli per Esterni

CrV

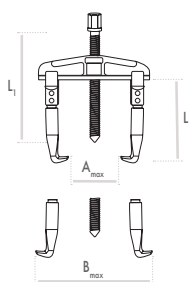

A min-A max	B min-Bmax	L	Filetto	L <sub>1</sub>	Tensione max.(KN)	Part N°	€
<b>30-90</b>	70-130	100	M14x1,5	130	30	<b>904-90-100</b>	<b>84,57</b>
<b>35-130</b>	80-180	100	M14x1,5	130	30	<b>904-130-100</b>	<b>86,00</b>
<b>40-160</b>	105-220	150	M20x2	210	42	<b>904-160-150</b>	<b>142,61</b>
<b>40-200</b>	120-270	150	M20x2	210	42	<b>904-200-150</b>	<b>196,36</b>
<b>60-250</b>	160-330	205	M27x2	280	60	<b>904-250-200</b>	<b>358,31</b>
<b>60-350</b>	160-420	205	M27x2	280	60	<b>904-350-200</b>	<b>397,47</b>
<b>90-520</b>	195-600	205	M27x2	280	60	<b>904-520-200</b>	<b>645,04</b>

904

Ricambi per Estrattori

L mm	L"	Bracci		Mandrino		Compatibile con
		Part N°	€/u.	Part N°	€	
<b>100</b>	4"	<b>904-001G</b>	<b>33,82</b>	<b>904-001H</b>	<b>25,37</b>	<b>904-90-100 / 904-130-100</b>
<b>150</b>	6"	<b>904-002G</b>	<b>57,05</b>	<b>904-002H</b>	<b>42,79</b>	<b>904-160-150 / 904-200-150</b>
<b>200</b>	8"	<b>904-003G</b>	<b>143,33</b>	<b>904-003H</b>	<b>71,66</b>	<b>904-250-200 / 904-350-200 / 904-520-200</b>

L mm	L"	Corpo		
		Part N°	€	Compatibile con
<b>100</b>	4"	<b>904-90-100C</b>	<b>33,82</b>	<b>904-90-100</b>
<b>100</b>	4"	<b>904-130-100C</b>	<b>36,12</b>	<b>904-130-100</b>
<b>150</b>	6"	<b>904-160-150C</b>	<b>57,05</b>	<b>904-160-150</b>
<b>150</b>	6"	<b>904-200-150C</b>	<b>78,54</b>	<b>904-200-150</b>
<b>200</b>	8"	<b>904-250-200C</b>	<b>100,33</b>	<b>904-250-200</b>
<b>200</b>	8"	<b>904-350-200C</b>	<b>119,24</b>	<b>904-350-200</b>
<b>200</b>	8"	<b>904-520-200C</b>	<b>354,76</b>	<b>904-520-200</b>

**Estrattori Meccanici**

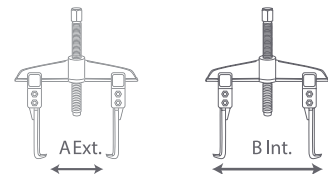

**905**

**Estrattore Multiplo a 2 Bracci per Esterni**

**Cr-V**

**100 mm**

**200 mm**

**250 mm**



L mm	A min-A max	B min-B max	Part N°	€
<b>100-250</b>	30-140	55-170	<b>905-001</b>	<b>272,45</b>

Bracci	Part N°	€
<b>905-001C</b>		<b>81,73</b>

Mandrino	Part N°	€
<b>905-001H</b>		<b>54,50</b>

Corpo		Part N°	€/u.
L mm	L"		
<b>100</b>	4"	<b>905-001G1</b>	<b>46,32</b>
<b>200</b>	8"	<b>905-001G2</b>	<b>57,21</b>
<b>250</b>	10"	<b>905-001G3</b>	<b>76,28</b>

**905**

**Estrattore Multiplo a 3 Bracci per Esterni**

**Cr-V**

**100 mm**

**200 mm**

**250 mm**



L mm	A min-A max	B min-B max	Part N°	€
<b>100-250</b>	30-140	70-170	<b>905-002</b>	<b>390,47</b>

Bracci	Part N°	€
<b>905-002C</b>		<b>97,62</b>

Mandrino	Part N°	€
<b>905-001H</b>		<b>54,50</b>

Corpo		Part N°	€/u.
L mm	L"		
<b>100</b>	4"	<b>905-001G1</b>	<b>46,32</b>
<b>200</b>	8"	<b>905-001G2</b>	<b>57,21</b>
<b>250</b>	10"	<b>905-001G3</b>	<b>76,28</b>



# Utensili Vari

Estrattori Meccanici



**905**

Estrattore Multiplo a 3 Bracci per Esterni

CrV

200  
mm

300  
mm



L mm	A min-A max	B min-B max	Part N°	€
<b>200-300</b>	40-220	110-270	<b>905-003</b>	<b>483,07</b>

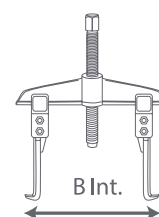
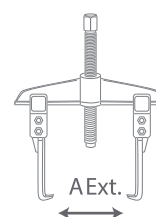

Corpo	
Part N°	€
<b>905-003C</b>	<b>130,43</b>

Mandrino	
Part N°	€
<b>905-003H</b>	<b>96,61</b>

Bracci			
L mm	L"	Part N°	€/u.
<b>200</b>	8"	<b>905-003G2</b>	<b>101,44</b>
<b>250</b>	10"	<b>905-003G3</b>	<b>111,11</b>

**905**

Estrattore Multiplo a 2 e 3 Bracci per Esterni

CrV

100  
mm

200  
mm

250  
mm



905-001

905-002

L mm	A min-A max	B min-B max	Part N°	€
<b>100-250</b>	30-140	55-170	<b>905-004</b>	<b>470,09</b>

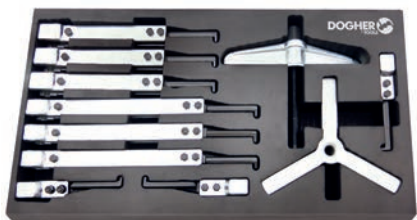
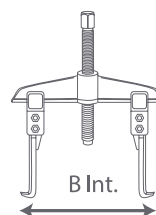
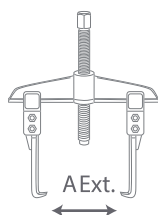

905-001



905-002

Corpo	€
Part N°	€
<b>905-001C</b>	<b>81,73</b>
<b>905-002C</b>	<b>97,62</b>

Mandrino	€
Part N°	€
<b>905-001H</b>	<b>54,50</b>

		Bracci	
L mm	L"	Part N°	€/u.
<b>100</b>	4"	<b>905-001G1</b>	<b>46,32</b>
<b>200</b>	8"	<b>905-001G2</b>	<b>57,21</b>
<b>250</b>	10"	<b>905-001G3</b>	<b>76,28</b>

# Utensili Vari

## Separatori



905

Kit di Separatori

CrV

30-50  
mm

50-75  
mm

min-max	Part N°	€
30-75	905-005	272,84



905

Separatore

CrV

30-50  
mm



min-max	Part N°	€
30-50	905-006	55,58

905

Estrattore per Separatore



Part N°	€
905-600	60,98

Compatibile con 905-006

905

Separatore

CrV

50-75  
mm



min-max	Part N°	€
50-75	905-007	74,97

905

Estrattore per Separatore



Part N°	€
905-700	60,98

Compatibile con 905-007

905

Separatore

CrV

75-105  
mm



min-max	Part N°	€
75-105	905-008	100,72

905

Estrattore per Separatore



Part N°	€
905-800	129,85

Compatibile con 905-008

905

Separatore

CrV

100-150  
mm



min-max	Part N°	€
100-150	905-009	284,59

905

Estrattore per Separatore



Part N°	€
905-900	133,63

Compatibile con 905-009



**Estrattori**

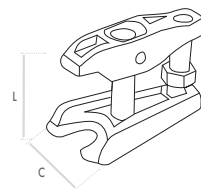

**905**

Estrattore per Snodi Sferici Universale

CrV

12-50  
mm

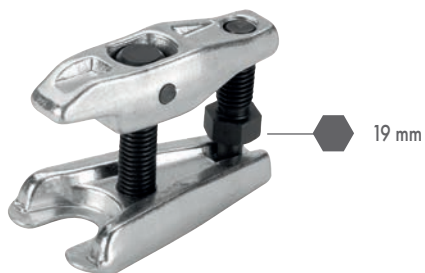

L min-max	C min-max	Part N°	€
<b>12-50</b>	18-22	<b>905-010</b>	<b>31,92</b>

**905**

Estrattore per Snodi Sferici

CrV

12-50  
mm

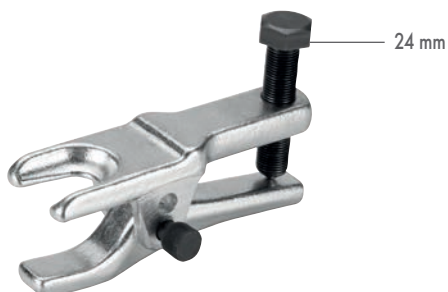

min-max	C	Part N°	€
<b>12-50</b>	20	<b>905-011</b>	<b>62,22</b>

**905**

Estrattore per Snodi Sferici

CrV

60-80  
mm



min-max	C	Part N°	€
<b>60-80</b>	20	<b>905-012</b>	<b>80,85</b>

**905**

Chiave Filtro 3 Bracci Regolabile



Ø mm	Part N°	€
<b>65-120</b>	<b>905-020</b>	<b>20,33</b>

# Utensili Vari

## Pistole per Sigillanti

- Manico e corpo in alluminio
- Forza di spinta: 1500 N
- Boccola di spinta rinforzata: 11 mm
- Avanzamento/Corsa: 10 mm
- Asta di spinta: 7,9 mm

**XTREME**

**914**

Pistola per Sgillanti a Triplo Pistone

225 mm  
Al  
1500 NW  
9"



L mm	Ø mm	Part N°	€
225	78	914-225	35,03



**915**

Pistola per Sigillanti con Taglio

225 mm  
Al  
1500 NW  
9"  
360°



L mm	Ø mm	Part N°	€
225	57	915-225	24,53



**916**

Pistola per Sigillanti a Ritorno Rapido

225 mm  
Al  
1500 NW  
9"  
360°



L mm	Ø mm	Part N°	€
225	55	916-225	22,28

**917**

Pistola per Sigillanti

225 mm  
Al  
4000 NW  
25:1  
9"  
360°



L mm	Ø mm	Part N°	€
225	55	917-225	37,13

**912**

Pistole per Sigillanti con Manico in Alluminio

Ø mm  
**50**



L mm	Ø mm	Part N°	€
<b>225</b>	55	<b>912-225</b>	<b>21,88</b>
<b>250</b>	55	<b>912-250</b>	<b>23,18</b>
<b>360</b>	55	<b>912-325</b>	<b>27,68</b>



**910**

Pistole per Sigillanti con Corpo in Acciaio

Ø mm  
**50**



L mm	Ø mm	Part N°	€
<b>225</b>	50	<b>910-225</b>	<b>7,17</b>
<b>250</b>	50	<b>910-250</b>	<b>7,48*</b>

\* Fino ad esaurimento scorte

**911**

Pistola per Sigillanti con Manico in Zinco

Ø mm  
**50**



L mm	Ø mm	Part N°	€
<b>225</b>	50	<b>911-225</b>	<b>10,01</b>

# Utensili Vari

## Pistole per Schiuma e per Cemento

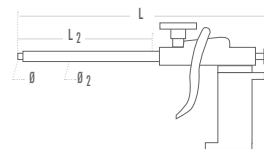

**913**

Pistole per Cemento Corpo in Alluminio

Ø mm  
**50**



L mm	Ø mm	Part N°	€
<b>225</b>	50	<b>913-225</b>	<b>24,83</b>
<b>300</b>	50	<b>913-300</b>	<b>25,92</b>
<b>375</b>	50	<b>913-375*</b>	<b>29,58</b>

- \* Capacità: 600 cm<sup>3</sup> / cartuccia
- Boccola di spinta rinforzata.

### Accessori per Pistole per Cemento

**913**

Beccucci di Ricambio per Pistola per Cemento

**2**  
Pcs

Adatto per  
**913**



Part N°	€ / 2Pcs
<b>913-001</b>	<b>1,85</b>

**914**

Pistola per Schiuma Poliuretana Pro

Ø mm  
**11**



L mm	L <sub>2</sub> mm	Ø mm	Ø <sub>2</sub> mm	Part N°	€
<b>325</b>	190	11	14	<b>914-001</b>	<b>41,63</b>

- Corpo rinforzato. L'asta e la valvola sono rivestite all'esterno e all'interno di teflon per garantire una maggiore durata.

**914**

Pistola per Schiuma Poliuretana

Ø mm  
**11**



L mm	L <sub>2</sub> mm	Ø mm	Ø <sub>2</sub> mm	Part N°	€
<b>325</b>	180	11	12	<b>914-002</b>	<b>31,40</b>

**915**

Pompa Grasso con Tubo Rigido

**10.000  
PSI**



- Valvola di sfato aria
- Carico alla rinfusa

1/8 BSP



Alla Rinfusa cc	Cartuccia gr	L pompa	Ø pompa	L Tubo Fless.	Ø Tubo Fless.	Part N°	€
500	400	380	57,5	190	9,5	<b>915-010</b>	<b>58,01</b>

**915**

Pompa Grasso con Tubo Flessibile

**3.000  
PSI**

1/8 BSP



**915-020**

**8.000  
PSI**

1/8 BSP



**915-030**



- Valvola di sfato aria
- Carico alla rinfusa

Alla Rinfusa cc	Cartuccia gr	L pompa	Ø pompa	L Tubo Fless.	Ø Tubo Fless.	Part N°	€
-	-	330	51,5	300	8,5	<b>915-020</b>	<b>35,03</b>
500	400	350	57,5	300	8,5	<b>915-030</b>	<b>38,18</b>

**915**

Tubo Flessibile per Pompa

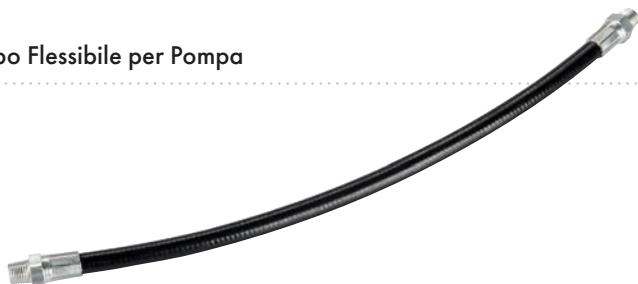

L mm	Part N°	€
<b>300</b>	<b>915-021</b>	<b>7,73</b>

**915**

Tubo Rigido per Pompa



L mm	Part N°	€
<b>190</b>	<b>915-022</b>	<b>7,73</b>



# Utensili Vari

## Rivettatrici



**918**

### Rivettatrice Serie Professionale

- Testine intercambiabili
- Include 4 testine Ø 2,4-3,2-4-4,8 mm.
- Molla per l'espulsione della parte eccedente del rivetto
- Manico ergonomico antiscivolo



Part N°	€
918-010	41,77

**918**

### Serie di Testine di Ricambio

- 4 Testine di ricambio per rivettatrice Ref. 918-010
- Include 1x Ø 2,4-3,2-4-4,8 mm



Part N°	€
918-1	4,39

**918**

### Rivettatrice Automatica

**4 in 1**

- Testina multipla
- 4 Taglie di rivetti Ø 2,4-3,2-4-4,8 mm
- Molla per l'espulsione della parte eccedente del rivetto
- Manico ergonomico antiscivolo



Part N°	€
918-012	36,42

**919**

### Rivettatrice a Due Mani con Testina Multidimensionale

- Mascelle in metallo duro
- Moltiplicatore di forza interno
- Manici ergonomici
- Corpo in alluminio
- Per Rivetti Ø 2,4-3,2-4-4,8-6,4 mm
- Rivetti in acciaio inox: Ø 2,4-3,2-4-4,8 mm

**XTREME**



L mm	L"	Part N°	€
320	13	919-016	77,09

**919**

### Mascelle e Testine di Ricambio

Mascelle		Testine		
Part N°	€	L mm	Part N°	€
919-016M	12,86	2,4	919-016-024	11,68
		3,2	919-016-032	11,68
		4,0	919-016-040	11,68
		4,8	919-016-048	11,68
		6,4	919-016-064	11,68



919

Rivettatrice Manuale Multifunzione



3 en  
in  
em 1

Part N°	€
919-020	148,76

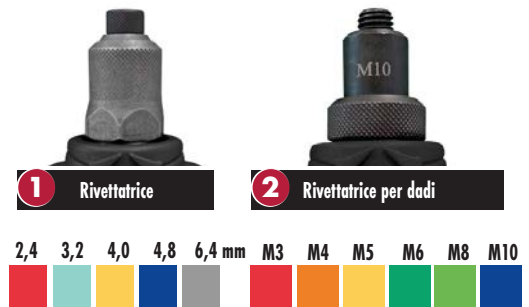

919

Ricambi per Rivettatrice

Mascelle	
Part N°	€
919-020M	12,98

Alesatore	
Part N°	€
919-020-EA	21,26
919-020-EB	21,26

Testine		
L mm	Part N°	€
2,4	919-020-024	12,62
3,2	919-020-032	12,62
4,0	919-020-040	12,62
4,8	919-020-048	12,62
6,4	919-020-064	12,62

Testine		
M	Part N°	€
M3	919-020-M3	20,33
M4	919-020-M4	20,33
M5	919-020-M5	20,33
M6	919-020-M6	20,33
M8	919-020-M8	20,33
M10	919-020-M10	20,33

919

Rivettatrice a Una Mano con Testine Multidimensionale per Dadi

- Testine intercambiabili
- Include 4 testine M3-M4-M5-M6.



L mm	L"	Part N°	€
210	8	919-022	95,81

# Utensili Vari

## Rivettatrici



919

Rivettatrice per Dadi

410  
mm

16"

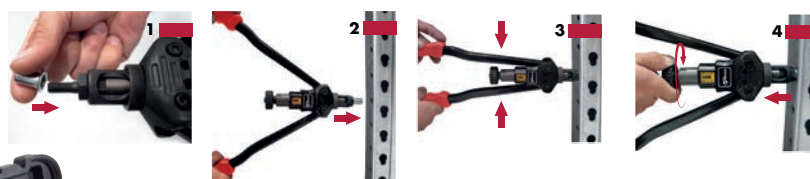

L mm	L"	Part N°	€
410	16	919-025	124,20

- Questa rivettatrice è speciale per i lavori intensivi.
- Rivettatrice ergonomica per ridurre lo sforzo.
- Facile sostituzione dei componenti.
- Include chiave multifunzione
- Include 7 testine M3-M4-M5-M6-M8-M10-M12.



919

Testine di Ricambio

M	Part N°	€
M3	919-025-M3	18,11
M4	919-025-M4	18,11
M5	919-025-M5	18,11
M6	919-025-M6	18,11
M8	919-025-M8	18,11
M10	919-025-M10	18,11
M12	919-025-M12	18,11

919

Rivettatrice per Dadi

- Testine intercambiabili
- Include 7 testine M3-M4-M5-M6-M8-M10-M12.



L mm	L"	Part N°	€
350	14	919-026	152,51



919

Testine di Ricambio

M	Part N°	€
M3	919-025-M3	18,11
M4	919-025-M4	18,11
M5	919-025-M5	18,11
M6	919-025-M6	18,11
M8	919-025-M8	18,11
M10	919-025-M10	18,11
M12	919-025-M12	18,11

**945** Ventosa



Ø mm	Capacità	Part N°	€
115	50 kg	945-001	19,41

- Corpo in alluminio con 1 testa.
- Utilizzare con una mano.
- Ideale per lavori nel settore automobilistico o del trasporto di prodotti.
- Utilizzare su superfici lisce non porose.

**945** Ventosa



Ø mm	Capacità	Part N°	€
115	100 kg	945-002	38,83

- Corpo in alluminio con 2 teste.
- Ideale per lavori nel settore automobilistico o del trasporto di prodotti.
- Utilizzare su superfici lisce non porose.

**945** Ventosa Doppia Snodata Speciale per Superfici Curve



Ø mm	Capacità	Part N°	€
118	80 kg	945-005	43,55

- Corpo con 2 teste.
- Impugnatura snodata, permette di flettersi adattandosi a superfici curve.
- Speciale per la manutenzione dei veicoli, installazione e rimozione di lamiera e vetri di macchina.

**945** Ventosa



Ø mm	Capacità	Part N°	€
115	130 kg	945-003	53,70

- Corpo in alluminio con 3 teste.
- Ideale per lavori automobilistici o trasporto di prodotti pesanti.
- Utilizzare su superfici lisce non porose.

**945** Ventosa



Ø mm	Capacità	Part N°	€
203	180 kg	945-004	102,25

- Ventosa ad alta resistenza con pompa manuale e disco in gomma da 203 mm
- Contrassegno di sicurezza rosso: avviso di perdita di aspirazione.
- Valvola manuale di rilascio della pressione.
- Da utilizzare su superfici strutturate e curve.



# Utensili Vari

Ventosa, Specchietto e Fustelle



945

Ventosa con Pompa del Vuoto Speciale per Vetri di Macchina.



Ø mm	Capacità	Part N°	€
230	200 kg	945-006	165,36

- Corpo in plastica con 1 testa.
- Speciale per superfici curve, in particolare vetri di macchina.



930

Specchietto Telescopico Snodato

Inox

- Specchietto di qualità industriale permette una visualizzazione perfetta in zone di difficile accesso
- Specchietto telescopico. Ripiegato: 240 mm. Esteso: fino a 930 mm
- Doppia articolazione permette di posizionare lo specchio in qualsiasi angolo
- Manico antiscivolo

360°



L min-max	Part N°	€
240-930	930-001	16,17



940

Pinza Fustellatrice Serie Professionale



- Fori puliti e precisi in cuoio, plastica, carta, tessuti...
- Ø 2-2,5-3-3,5-4-4,5 mm
- Manici Ergonomici in PVC



Part N°	€
940-001	23,76

940

Punzone con Fustelle Intercambiabili



- Manico zigrinato antiscivolo
- Ø 2-2,5-3-3,5-4-4,5 mm



Part N°	€
940-002	21,61



**925**

Morse Parallele da Banco Guida Tonda

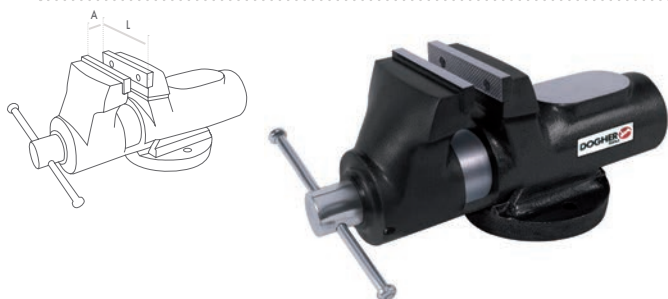

L mm	A mm	Kg	Part N°	€
100	105	13	925-100	339,42
125	130	22	925-125	467,36
150	165	32	925-150	667,33

**926**

Morse Parallele da Banco Guida Quadra

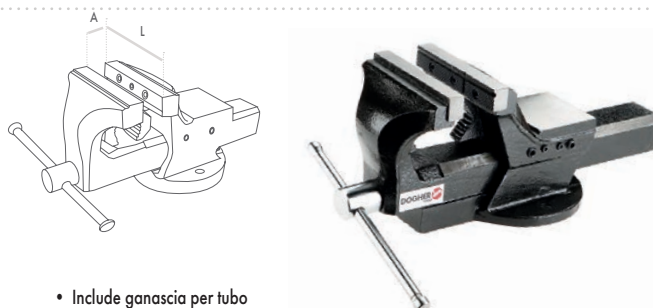

• Include ganasce per tubo

L mm	A mm	Kg	Part N°	€
100	105	7,5	926-100	226,98
125	155	14	926-125	252,93
150	165	19	926-150	365,17
175	205	26	926-175	578,33

**925R**

Ganasce di Ricambio

Adatta per  
925

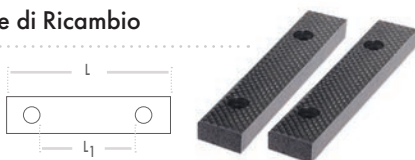

L mm	L <sub>1</sub> mm	Part N°	€/ 2Pcs
100	53	925R-100	27,74
125	73	925R-125	41,06
150	88	925R-150	50,23

**926R**

Ganasce di Ricambio

Adatta per  
926

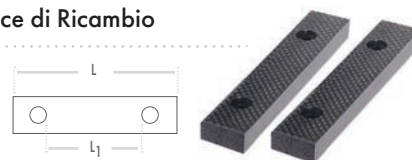

L mm	L <sub>1</sub> mm	Part N°	€/ 2Pcs
100	24	926R-100	33,41
125	28	926R-125	39,42
150	43	926R-150	45,00
175	53	926R-175	50,38

**925B**

Basi Girevoli

Adatta per  
925



L mm	Part N°	€
100	925B-100	37,03
125	925B-125	41,61
150	925B-150	59,92

**926B**

Basi Girevoli

Adatta per  
926



L mm	Part N°	€
100	926B-100	32,99
125	926B-125	35,36
150	926B-150	45,42
175	926B-175	71,72

## Utensili Vari

Morse Parallele da Banco e Chiave Filtra

**DOGHER**  
TOOLS

**927**

Morsa da Banco

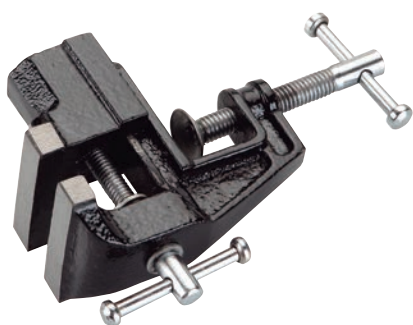

L mm	Part N°	€
50	927-050	18,90



**927**

Morsa da Banco



L mm	Part N°	€
90	927-060	34,51

• Apertura massima: 40 mm

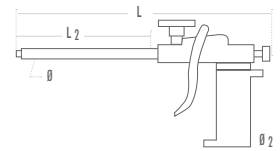

**914** Pistola di Soffiaggio Progressiva

Ø mm  
8



L mm	L <sub>2</sub> mm	Ø mm	Ø <sub>2</sub> mm	Part N°	€
<b>210</b>	100	8	1/4" G (BSP)	<b>914-010</b>	<b>19,32</b>

- Pressione massima: 12 Bar · 175 PSI · 1.2 Mpa
- Ugello con rinforzo metallico.
- Corpo in POM (Acetale) ad alte prestazioni.

**914** Pistola di Soffiaggio Progressiva

Ø mm  
8



L mm	L <sub>2</sub> mm	Ø mm	Ø <sub>2</sub> mm	Part N°	€
<b>306</b>	202	8	1/4" G (BSP)	<b>914-015</b>	<b>22,66</b>

- Pressione massima: 12 Bar · 175 PSI · 1.2 Mpa
- Ugello con rinforzo metallico.
- Corpo in POM (Acetale) ad alte prestazioni.

**914** Pistola di Soffiaggio Progressiva

Ø mm  
8



L mm	L <sub>2</sub> mm	Ø mm	Ø <sub>2</sub> mm	Part N°	€
<b>212</b>	93	8	1/4" G (BSP)	<b>914-020</b>	<b>24,48</b>

- Basso livello di rumorosità
  - Pressione massima: 12 Bar · 175 PSI · 1.2 Mpa
  - Ugello con rinforzo metallico.
  - Corpo in POM (Acetale) ad alte prestazioni.
  - Prodotto secondo le normative OSHA.
- Amministrazione per la sicurezza e la salute sul lavoro.



# Utensili Vari

## Fustellatrici



### Fustellatrici a testa intercambiabile:

Le nuove Fustellatrici **XTREME** consentono all'operatore di eseguire fori di precisione per ottenere guarnizioni, rondelle, ecc.

I cambi di fustelle e mandrini sono veloci attraverso il filetto o i sistemi **FASTClick**.

- Le fustelle da 2 a 10 mm di diametro sono fissate alla fustellatrice mediante una filettatura interna M13x1.
- Le fustelle da 11 a 60 mm di diametro sono fissati alla fustellatrice mediante il sistema **FASTClick**.
- I mandrini 940-250M e 940-260M sono fissati alla fustellatrice 940-02-60 mediante una filettatura di M20x1,5.

Il suo utilizzo è consigliato su lastre di alluminio, acciaio, pelle, gomma, cartone, gommapiuma, plastica, fibra...

### CAPACITÀ DI TAGLIO

Piastre in Acciaio-Rame-Alluminio: 0,3 mm di spessore.



940

Fustellatrici in Acciaio



L mm	Ø mm	Part N°	€
120	16	940-02-10	30,91

- Per Fustelle di Ø 2 - 10 mm

940

Fustellatrici in Acciaio



L mm	Ø mm	Part N°	€
95	24	940-03-20	42,12

- Per Fustelle di Ø 2 - 20 mm

940

Fustellatrici Bimateriale



L mm	Ø mm	Part N°	€
180	34,5	940-02-60	107,92

- Per Fustelle di Ø 2 - 60 mm

940

Fustellatrici Bimateriale



L mm	Ø mm	Part N°	€
180	35	940-03-30	117,51

- Per Fustelle di Ø 2 - 30 mm



**940**

Fustelle di Ricambio per Fustellatrice

► Fustelle Ø 2 - 10 mm  
Filettatura M13x1

Ø mm	L mm	Part N°	€
2	27	940-102	11,64
3	27	940-103	11,64
4	27	940-104	11,64
5	27	940-105	11,64
6	27	940-106	11,64
7	27	940-107	11,64
8	27	940-108	11,64
9	27	940-109	11,64
10	27	940-110	11,64

► Fustelle Ø 11 - 60 mm



Ø mm	L mm	Part N°	€
11	27	940-111	14,47
12	27	940-112	14,47
13	27	940-113	14,47
14	27	940-114	14,47
15	27	940-115	14,47
16	27	940-116	14,47
17	27	940-117	14,47
18	27	940-118	14,47
19	27	940-119	14,47
20	27	940-120	14,47
21	32	940-121	19,13
22	32	940-122	19,13
23	32	940-123	19,13
24	32	940-124	19,13
25	32	940-125	19,13
26	32	940-126	19,13
27	32	940-127	19,13
28	32	940-128	19,13
29	32	940-129	19,13
30	32	940-130	19,13
32	37	940-132	24,64
33	37	940-133	24,64
34	37	940-134	24,64
35	37	940-135	24,64
36	37	940-136	24,64
37	37	940-137	24,64
38	37	940-138	24,64
39	37	940-139	24,64
40	37	940-140	24,64
42	42	940-142	28,58
43	42	940-143	28,58
44	42	940-144	28,58
45	42	940-145	28,58
46	42	940-146	28,58
47	42	940-147	28,58
48	42	940-148	28,58
49	42	940-149	28,58
50	42	940-150	28,58
52	47	940-152	72,91
54	47	940-154	72,91
56	47	940-156	72,91
58	47	940-158	72,91
60	47	940-160	72,91





# Utensili Vari

## Fustellatrici



940

Punta di Centraggio

Ø: 4,8 mm



Ø: 14 mm

L mm	Ø mm	Part N°	€
54	14	940-210	30,91

940

Barra per Compasso

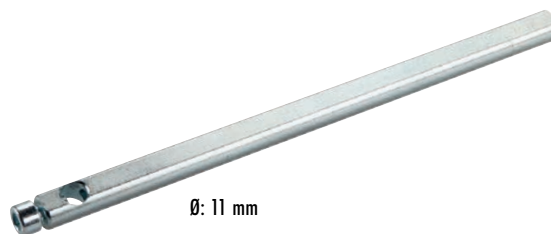

Ø: 11 mm

L mm	Ø mm	Part N°	€
420	11	940-211	18,92

940

Taglierina per Compasso



L mm	Ø mm	Part N°	€
124	16	940-212	28,12

- Include lama 940-213

940

Lama di Taglierina per Compasso



Part N°	€
940-213	18,67

940

Mandrino a Piramide

Part N°	€
940-250M	74,93

- Viene utilizzato nella fustellatrice 940-02-60  
Incluso nella serie 940-250



Part N°	€
940-260M	108,17

- Viene utilizzato nella fustellatrice 940-02-60  
Incluso nella serie 940-260



940

Set Fustellatrice in Acciaio + Fustelle intercambiabile



940-03-20 Ø 2 - 20 mm



940-103 Ø 3  
940-104 Ø 4  
940-106 Ø 6  
940-108 Ø 8  
940-110 Ø 10



**Fast  
Click**

940-112 Ø 12  
940-114 Ø 14  
940-116 Ø 16  
940-118 Ø 18  
940-120 Ø 20

Part N°	€
940-320	128,33



**11  
Pcs**



940

Set di Fustellatrice Bimateriale + Fustelle intercambiabile



940-03-30 Ø 2 - 30 mm



940-103 Ø 3  
940-104 Ø 4  
940-106 Ø 6  
940-108 Ø 8  
940-110 Ø 10



**Fast  
Click**

940-112 Ø 12  
940-114 Ø 14  
940-116 Ø 16  
940-118 Ø 18  
940-120 Ø 20  
940-122 Ø 22  
940-124 Ø 24  
940-126 Ø 26  
940-128 Ø 28  
940-130 Ø 30

Part N°	€
940-330	257,25



**16  
Pcs**



# Utensili Vari

Fustellatrici



940

Set di Fustellatrice Bimateriale + Fustelle Intercambiabile + Mandrino a Piramide + Punta di Centraggio



940-02-60 Ø 2 - 60 mm



940-102 Ø 2  
940-103 Ø 3  
940-104 Ø 4  
940-105 Ø 5  
940-106 Ø 6  
940-107 Ø 7  
940-108 Ø 8  
940-109 Ø 9  
940-110 Ø 10



940-112 Ø 12  
940-114 Ø 14  
940-116 Ø 16  
940-118 Ø 18  
940-120 Ø 20  
940-122 Ø 22  
940-124 Ø 24  
940-126 Ø 26  
940-128 Ø 28  
940-130 Ø 30  
940-132 Ø 32  
940-134 Ø 34  
940-136 Ø 36  
940-138 Ø 38  
940-140 Ø 40  
940-142 Ø 42  
940-144 Ø 44  
940-146 Ø 46  
940-148 Ø 48  
940-150 Ø 50



940-210 940-250M Ø 2 - 50 mm

**32**  
Pcs



Part N°	€
940-250	502,25

940

Set di Fustellatrice Bimateriale + Fustelle Intercambiabile + Mandrino a Piramide + Punta di Centraggio + Barra per compasso



940-02-60 Ø 2 - 60 mm



940-102 Ø 2  
940-103 Ø 3  
940-104 Ø 4  
940-105 Ø 5  
940-106 Ø 6  
940-107 Ø 7  
940-108 Ø 8  
940-109 Ø 9  
940-110 Ø 10



940-112 Ø 12  
940-114 Ø 14  
940-116 Ø 16  
940-118 Ø 18  
940-120 Ø 20  
940-122 Ø 22  
940-124 Ø 24  
940-126 Ø 26  
940-128 Ø 28  
940-130 Ø 30  
940-132 Ø 32  
940-134 Ø 34  
940-136 Ø 36  
940-138 Ø 38  
940-140 Ø 40  
940-142 Ø 42  
940-144 Ø 44  
940-146 Ø 46  
940-148 Ø 48  
940-150 Ø 50  
940-152 Ø 52  
940-154 Ø 54  
940-156 Ø 56  
940-158 Ø 58  
940-160 Ø 60



940-210 940-260M Ø 2 - 60 mm



940-213 940-212 940-211

**39**  
Pcs



Part N°	€
940-260	875,84