

DOGHER

® TOOLS

Making Solutions



	188
	192
	196
	203
	208
	212
	213
	218
	220
	223
	226
	228

	232
	233
	235
	236
	237
	238
	239
	240
	243

Chiavi 450

Chiavi Regolabili

Chiavi a Rullino Laterale e a Grande Apertura



491

Chiavi Regolabili a Rullino Laterale

CrV

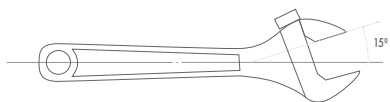

L mm	L "	mm	Part N°	€
150	6	24	491-150	37,67
200	8	29	491-200	41,84
250	10	33	491-250	51,91
300	12	38	491-300	67,00
400	16	50	491-400	111,96
500	20	62	491-500	197,49



230 x 210 x 155 mm

EXP

Espositore di Chiavi Regolabili a Rullino Laterale

10
Pcs

CrV



491-200 (x4)
491-250 (x6)

Part N°	€
491-001J	478,81

492

Chiavi Regolabili a Grande Apertura

CrV

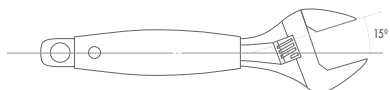

L mm	L "	mm	Part N°	€
150	6	34	492-150	32,82
200	8	38	492-200	35,61
250	10	50	492-250	44,47

Chiavi a Rullino Centrale

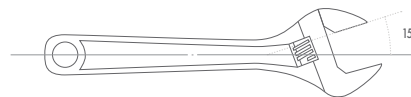

493

Chiavi Regolabili Professionali a Rullino Centrale

CrV



230 x 210 x 155 mm

L mm	L "	mm	Part N°	€
100	4	17	493-100	19,35
150	6	24	493-150	20,28
200	8	29	493-200	24,08
250	10	33	493-250	30,22
300	12	38	493-300	40,71
380	15	50	493-380	76,97
450	18	60	493-450	119,74
600	24	70	493-600	294,77

EXP

Espositore di Chiavi Regolabili Professionali a Rullino Centrale

10
Pcs

CrV

Part N°	€
493-001J	277,60

493-200 (x4)

493-250 (x6)



4930

Chiavi Regolabili STD a Rullino Centrale

CrV



230 x 210 x 155 mm

L mm	L "	mm	Part N°	€
100	4	13	4930-100	16,81
150	6	19	4930-150	16,97
200	8	24	4930-200	19,59
250	10	28	4930-250	24,61
300	12	34	4930-300	31,78
380	15	43	4930-380	57,10
450	18	52	4930-450	96,14
600	24	62	4930-600	203,39

EXP

Espositore di Chiavi Regolabili STD a Rullino Centrale

10
Pcs

CrV

Part N°	€
4930-001J	226,04

4930-200 (x4)

4930-250 (x6)



Chiavi Regolabili

Chiavi a Cricchetto e Alligator



496

Chiavi Regolabili a Cricchetto

CrV

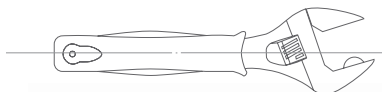

L mm	L "	mm	Part N°	€
150	6	6~20	496-150	31,59
200	8	6~24	496-200	36,26
250	10	6~30	496-250	53,85

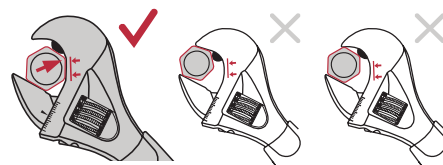

• Posizioni la chiave come illustrato nell'immagine.



160 x 190 x 125 mm

EXP

Espositore di Chiavi Regolabili a Cricchetto

10
Pcs

CrV



496-200 (x10)

Part N°	€
496-001J	362,62

4931

Chiave Regolabile **Alligator**

CrV



L mm	L "	mm	mm	Part N°	€
200	8	32	M3-M10	4931-200	39,80

EXP

Espositore di Chiavi Regolabili Alligator

10
Pcs

CrV



230 x 210 x 155 mm



4931-200 (x10)

Part N°	€
4931-200J	397,95

491

Vaschetta Modulare
Chiavi a Rullino Laterale

3
Pcs

CrV



1/4 (375 x 140 x 30 mm)



150mm • 200mm • 250mm

Part N°	€
491-080	140,67

493

Vaschetta Modulare
Chiavi a Rullino Centrale

3
Pcs

CrV



1/4 (375 x 140 x 30 mm)



150mm • 200mm • 250mm

Part N°	€
493-080	83,82

Per maggiori informazioni sullo stoccaggio e vaschette modulari consulti le pagine:

20 • 35

Chiavi Fisse

Tutte le chiavi DOGHER sono forgiate in Cromo Vanadio e temprate attraverso un riscaldamento continuo e raffreddamento in olio. Questo processo conferisce all'utensile una grande durezza e tenacità. Tutto il corpo risulta pulito aumentando al massimo la resistenza all'ossidazione.

Chiavi a Forchetta Doppie

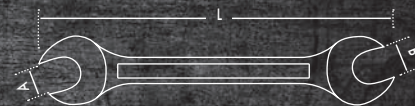

450

Chiavi a Forchetta Doppie

CrV



SAE

A mm	B mm	L mm	Part N°	€
4	5	110	450-04-05	5,28
4,5	5,5	123	450-04,5-05,5	5,28
5	5,5	123	450-05-05,5	5,28
5,5	7	123	450-05,5-07	5,19
6	7	123	450-06-07	4,92
7	8	129	450-07-08	5,15
8	9	140	450-08-09	5,01
8	10	141	450-08-10	5,79
10	11	155	450-10-11	5,79
10	12	156	450-10-12	6,93
10	13	170	450-10-13	7,09
11	13	172	450-11-13	7,09
12	13	172	450-12-13	7,27
12	14	179	450-12-14	7,59
13	15	189	450-13-15	7,91
13	17	205	450-13-17	8,89
14	15	190	450-14-15	7,40
16	17	204	450-16-17	8,60
16	18	210	450-16-18	8,89
17	19	221	450-17-19	9,91
18	19	220	450-18-19	10,26
19	22	237	450-19-22	12,12
20	22	237	450-20-22	12,21
21	23	247	450-21-23	13,37
22	24	247	450-22-24	13,44
24	26	263	450-24-26	15,56
24	27	266	450-24-27	15,83
25	28	280	450-25-28	18,18
27	29	280	450-27-29	20,70
27	30	285	450-27-30	22,25
27	32	300	450-27-32	24,06
30	32	298	450-30-32	23,89
32	36	350	450-32-36	43,85
34	36	350	450-34-36	48,58
36	41	380	450-36-41	54,11
41	46	415	450-41-46	75,77
46	50	465	450-46-50	99,26

A "	B "	L mm	Part N°	€
1/4"	5/16"	123	450-1/4-5/16	5,72
5/16"	3/8"	140	450-5/16-3/8	5,94
3/8"	7/16"	156	450-3/8-7/16	6,93
7/16"	1/2"	172	450-7/16-1/2	8,25
1/2"	9/16"	172	450-1/2-9/16	8,25
9/16"	5/8"	188	450-9/16-5/8	8,80
5/8"	11/16"	204	450-5/8-11/16	10,19
11/16"	3/4"	220	450-11/16-3/4	11,18
13/16"	7/8"	238	450-13/16-7/8	13,41
15/16"	1"	266	450-15/16-1	17,99
1"	1.1/8"	280	450-1-1.1/8	21,62
1.1/16"	1.1/4"	298	450-1.1/16-1.1/4	27,38



• Consultare per confezione singola

450

Busta in Nylon

8

Pcs

CrV



390 x 300 mm



- 6x7 • 8x9 • 10x11 • 12x13 • 14x15 • 16x17
- 18x19 • 20x22

Part N°	€
450-001	67,71
450-001V *	20,29

* Busta in Nylon Vuota

450

Busta in Nylon

12

Pcs

CrV



620 x 350 mm



- 6x7 • 8x9 • 10x11 • 12x13 • 14x15 • 16x17
- 18x19 • 20x22 • 21x23 • 24x27 • 25x28 • 30x32

Part N°	€
450-002	139,97
450-002V *	23,23

* Busta in Nylon Vuota

450

Busta in Nylon

7

Pcs

CrV

SAE



300 x 390 mm



- 1/4" x 5/16" • 5/16" x 3/8" • 3/8" x 7/16"
- 1/2" x 9/16" • 9/16" x 5/8" • 5/8" x 11/16"
- 11/16" x 3/4"

Part N°	€
450-003	63,27
450-003V *	20,29

* Busta in Nylon Vuota

450

Busta in Nylon

11

Pcs

CrV

SAE



620 x 350 mm



- 1/4" x 5/16" • 5/16" x 3/8" • 3/8" x 7/16"
- 1/2" x 9/16" • 9/16" x 5/8" • 5/8" x 11/16"
- 11/16" x 3/4" • 13/16" x 7/8" • 15/16" x 1"
- 1" x 1.1/8" • 1.1/16" x 1.1/4"

Part N°	€
450-004	144,66
450-004V *	23,23

* Busta in Nylon Vuota

Chiavi Fisse

Serie di Chiavi a Forchetta Doppie



450

Supporto in Plastica

6
Pcs

CrV



• 6x7 • 8x9 • 10x11 • 12x13 • 14x15 • 16x17

Part N°	€
450-016	47,24
450-011V *	14,85

* Supporto in Plastica Vuoto

8
Pcs

CrV



• 6x7 • 8x9 • 10x11 • 12x13 • 14x15 • 16x17
• 18x19 • 20x22

Part N°	€
450-018	69,71
450-013V *	17,31

* Supporto in Plastica Vuoto

450

Supporto in Plastica

10
Pcs

CrV



• 6x7 • 8x9 • 10x11 • 12x13 • 14x15 • 16x17
• 18x19 • 20x22 • 21x23 • 24x27

Part N°	€
450-020	98,91
450-015V *	22,26

* Supporto in Plastica Vuoto

12
Pcs

CrV



• 6x7 • 8x9 • 10x11 • 12x13 • 14x15 • 16x17
• 18x19 • 20x22 • 21x23 • 24x27 • 25x28 • 27x29

Part N°	€
450-022	137,78
450-017V *	23,51

* Supporto in Plastica Vuoto

12
Pcs

CrV



• 6x7 • 8x9 • 10x11 • 12x13 • 14x15 • 16x17
• 18x19 • 20x22 • 21x23 • 24x26 • 25x28 • 30x32

Part N°	€
450-024	140,70
450-017V *	23,51

* Supporto in Plastica Vuoto

450

Scatola di Cartone

5
Pcs

CrV



• 6x7 • 8x9 • 10x11 • 12x13 • 14x15

Part N°	€
450-035	38,64

450

Scatola di Cartone

6
Pcs

CrV



• 6x7 • 8x9 • 10x11 • 12x13 • 14x15 • 16x17

Part N°	€
450-036	47,24

450

Scatola di Cartone

8
Pcs

CrV



• 6x7 • 8x9 • 10x11 • 12x13
• 14x15 • 16x17 • 18x19 • 20x22

Part N°	€
450-038	69,71

450

Vaschetta Modulare

8
Pcs

CrV



1/4 (375 x 140 x 30 mm)



• 6x7 • 8x9 • 10x11 • 12x13 • 14x15
• 16x17 • 18x19 • 20x22

Part N°	€
450-080	70,71

450

Vaschetta Modulare

10
Pcs

CrV



1/3 (375 x 188 x 30 mm)



• 6x7 • 8x9 • 10x11 • 12x13 • 14x15
• 16x17 • 18x19 • 20x22 • 21x23 • 24x26

Part N°	€
450-081	102,88

450

Vaschetta Modulare

3
Pcs

CrV



1/3 (375 x 188 x 30 mm)



• 25x28 • 27x29 • 30x32

Part N°	€
450-082	75,26

Chiavi Fisse

Chiavi Combinate

- Distribuzione ottima delle cariche
- Fissaggio rapido
- Massimo rendimento senza usura
- Diminuzione dei danni a viti e bulloni
- Maggiore vita utile della chiave
- Massima superficie di contatto
- Distribuzione omogenea dello sforzo

Effetto dello sforzo:

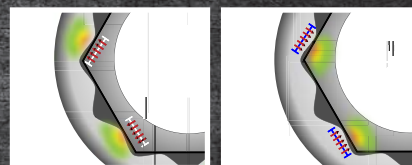

• Sulla chiave

• Sul bullone

451

Chiavi Combinate

CrV

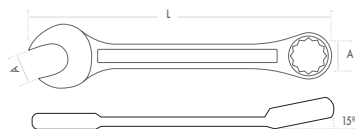

SAE

A"	L mm	Part N°	€
7/32"	100	451-7/32	6,98
1/4"	100	451-1/4	5,95
9/32"	110	451-9/32	6,53
5/16"	120	451-5/16	6,15
11/32"	130	451-11/32	6,53
3/8"	140	451-3/8	7,26
7/16"	150	451-7/16	8,01
1/2"	170	451-1/2	9,02
9/16"	180	451-9/16	9,20
5/8"	200	451-5/8	10,22
11/16"	210	451-11/16	10,99
3/4"	230	451-3/4	13,02
13/16"	250	451-13/16	15,05
7/8"	260	451-7/8	15,35
15/16"	280	451-15/16	16,79
1"	290	451-1	18,32
1.1/16"	310	451-1.1/16	24,06
1.1/8"	330	451-1.1/8	25,55
1.1/4"	360	451-1.1/4	35,84
1.5/16"	380	451-1.5/16	44,03
1.3/8"	410	451-1.3/8	60,96
1.7/16"	410	451-1.7/16	61,97
1.1/2"	410	451-1.1/2	64,07
1.5/8"	460	451-1.5/8	77,42
1.11/16"	460	451-1.11/16	101,66
1.3/4"	500	451-1.3/4	107,29
1.13/16"	500	451-1.13/16	101,45
1.7/8"	540	451-1.7/8	114,14
2"	540	451-2	115,68
2.1/8"	560	451-2.1/8	200,55
2.1/4"	600	451-2.1/4	200,55
2.3/8"	600	451-2.3/8	281,28
2.1/2"	680	451-2.1/2	348,60
2.5/8"	680	451-2.5/8	348,60
2.3/4"	680	451-2.3/4	370,78
2.7/8"	730	451-2.7/8	450,01
3"	730	451-3	450,01

A mm	L mm	Part N°	€
4	80	451-04	8,89
5,5	100	451-05,5	5,59
6	100	451-06	5,64
7	110	451-07	5,78
8	120	451-08	5,88
9	130	451-09	6,76
10	140	451-10	6,94
11	150	451-11	7,76
12	160	451-12	8,18
13	170	451-13	8,45
14	180	451-14	8,91
15	190	451-15	9,19
16	200	451-16	9,59
17	210	451-17	10,20
18	220	451-18	10,82
19	230	451-19	12,34
20	240	451-20	12,94
21	250	451-21	14,64
22	260	451-22	14,56
23	270	451-23	15,84
24	280	451-24	16,14
25	290	451-25	17,92
26	300	451-26	19,92
27	310	451-27	21,17
28	320	451-28	23,24
29	330	451-29	23,59
30	340	451-30	24,73
32	360	451-32	26,64
33	380	451-33	52,62
34	380	451-34	49,64
35	410	451-35	64,23
36	410	451-36	60,22
38	430	451-38	65,37
41	460	451-41	69,67
43	460	451-43	108,49
46	500	451-46	98,26
48	540	451-48	136,92
50	540	451-50	109,77
55	560	451-55	190,51
58	600	451-58	288,39
60	600	451-60	252,35
65	680	451-65	336,37
70	680	451-70	395,81
75	730	451-75	509,41
80	730	451-80	583,73
85	790	451-85	789,92
90	790	451-90	1.022,37
95	790	451-95	1.081,25
100	860	451-100	1.152,88
105	860	451-105	1.190,25

451

Busta in Nylon

14
Pcs

CrV



470 x 390 mm



Part N°	€
451-001	148,52
451-001V *	20,11

* Busta in Nylon Vuota

451

Busta in Nylon

14
Pcs

CrV



650 x 440 mm



Part N°	€
451-002	187,16
451-002V *	23,47

* Busta in Nylon Vuota

451

Busta in Nylon

17
Pcs

CrV



470 x 450 mm



Part N°	€
451-003	168,81
451-003V *	20,11

* Busta in Nylon Vuota

451

Busta in Nylon

18
Pcs

CrV



650 x 480 mm



Part N°	€
451-004	244,06
451-004V *	22,58

* Busta in Nylon Vuota

Chiavi Fisse

Serie di Chiavi Combinate



451

Busta in Nylon

24
Pcs

CrV

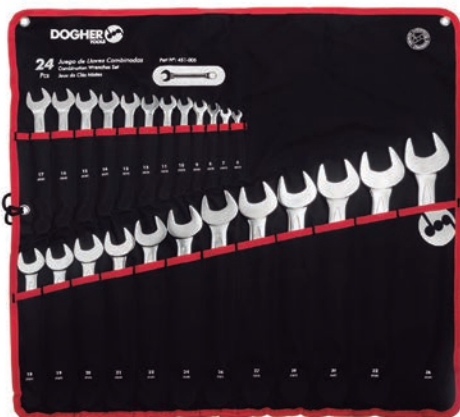

650 x 580 mm

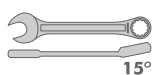

•6 •7 •8 •9 •10 •11 •12 •13 •14
•15 •16 •17 •18 •19 •20 •21 •22 •24
•26 •27 •28 •30 •32 •36

Part N°	€
451-005	360,86
451-005V *	27,33

* Busta in Nylon Vuota

451

Busta in Nylon

26
Pcs

CrV



650 x 500 mm

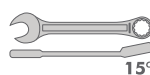

•6 •7 •8 •9 •10 •11 •12 •13 •14
•15 •16 •17 •18 •19 •20 •21 •22 •23
•24 •25 •26 •27 •28 •29 •30 •32

Part N°	€
451-006	358,00
451-006V *	27,33

* Busta in Nylon Vuota

451

Busta in Nylon

8
Pcs

SAE

CrV



330 x 300 mm

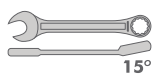

•1/4" •5/16" •3/8" •7/16" •1/2" •9/16"
•5/8" •11/16"

Part N°	€
451-007	73,05
451-007V *	18,33

* Busta in Nylon Vuota

451

Busta in Nylon

12
Pcs

SAE

CrV



550 x 350 mm

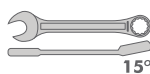

•3/8" •7/16" •1/2" •9/16" •5/8" •11/16"
•3/4" •13/16" •7/8" •15/16" •1" •1.1/16"

Part N°	€
451-008	164,53
451-008V *	22,93

* Busta in Nylon Vuota

451

Busta in Nylon

14
Pcs

SAE

CrV



650 x 440 mm

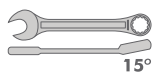

• 3/8" • 7/16" • 1/2" • 9/16" • 5/8"
• 11/16" • 3/4" • 13/16" • 7/8" • 15/16"
• 1" • 1.1/16" • 1.1/8" • 1.1/4"

Part N°	€
451-009	226,91
451-009V *	23,47

* Busta in Nylon Vuota

451

Scatola di Cartone

5
Pcs

CrV

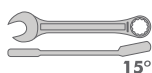

• 8 • 10 • 11 • 12 • 13

Part N°	€
451-035	45,46

451

Scatola di Cartone

6

Pcs

CrV

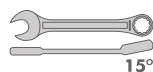

• 8 • 10 • 11 • 12 • 13 • 14

Part N°	€
451-036	54,38

451

Scatola di Cartone

8

Pcs

CrV

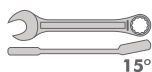

• 8 • 10 • 11 • 12 • 13 • 14 • 17 • 19

Part N°	€
451-038	76,91

Chiavi Fisse

Serie di Chiavi Combinate



451

Supporto in Plastica

5
Pcs

CrV

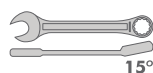

8 • 10 • 13 • 17 • 19

6
Pcs

CrV

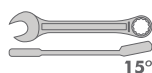

8 • 10 • 11 • 13 • 17 • 19

6
Pcs

CrV

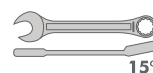

8 • 10 • 11 • 12 • 13 • 14

Part N°	€
451-014	52,06
450-011V *	14,85

* Supporto in Plastica Vuoto

Part N°	€
451-015	59,82
450-011V *	14,85

* Supporto in Plastica Vuoto

Part N°	€
451-016	54,38
450-011V *	14,85

* Supporto in Plastica Vuoto

451

Supporto in Plastica

8
Pcs

CrV

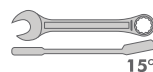

8 • 10 • 11 • 12 • 13 • 14 • 17 • 19

10
Pcs

CrV

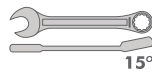

8 • 9 • 10 • 11 • 12
13 • 14 • 15 • 16 • 17

12
Pcs

CrV

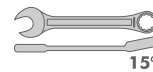

8 • 9 • 10 • 11 • 12 • 13
14 • 15 • 16 • 17 • 18 • 19

Part N°	€
451-018	76,91
450-013V *	17,31

* Supporto in Plastica Vuoto

Part N°	€
451-020	90,11
450-015V *	22,26

* Supporto in Plastica Vuoto

Part N°	€
451-022	113,26
450-017V *	23,51

* Supporto in Plastica Vuoto

451

Vaschetta Modulare

8
Pcs

CrV



1/4 (375 x 140 x 30 mm)

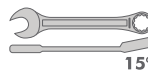

• 8 • 10 • 11 • 12 • 13 • 14 • 17 • 19

Part N°	€
451-080	77,91

451

Vaschetta Modulare

11
Pcs

CrV



1/3 (375 x 188 x 30 mm)

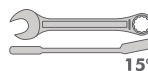

• 7 • 8 • 10 • 11 • 12 • 13 • 14
• 17 • 19 • 22 • 24

Part N°	€
451-082	117,64

451

Chiavi Combinate

10
Pcs



1/3 (375 x 188 x 30 mm)

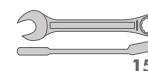

• 8 • 10 • 11 • 12 • 13 • 14 • 17 • 19 • 22 • 24

Part N°	€
451-081	111,86*

* Fino ad esaurimento scorte

451

Vaschetta Modulare

3
Pcs

CrV



1/3 (375 x 188 x 30 mm)

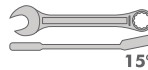

• 27 • 30 • 32

Part N°	€
451-083	85,03

Chiavi Fisse

Chiavi Combinate Lunghe e Twist

DOGHER
TOOLS

4551

Chiavi Combinate Lunghe



A mm	L mm	Part N°	€
7	136	4551-07	9,52
8	148	4551-08	9,70
9	167	4551-09	9,70
10	172	4551-10	10,71
11	186	4551-11	10,71
12	197	4551-12	12,26
13	207	4551-13	12,26
15	233	4551-15	14,79
17	261	4551-17	16,74
19	280	4551-19	21,21
21	301	4551-21	21,21
24	338	4551-24	27,13
27	375	4551-27	35,20
32	435	4551-32	42,59

4561

Chiavi Combinate Twist



A mm	L mm	Part N°	€
6	110	4561-06	10,54
7	120	4561-07	10,54
8	130	4561-08	10,75
9	140	4561-09	10,75
10	150	4561-10	11,87
11	160	4561-11	11,87
12	170	4561-12	13,58
13	180	4561-13	13,58
14	190	4561-14	16,39
15	200	4561-15	16,39
16	210	4561-16	17,99
17	220	4561-17	18,54
18	230	4561-18	18,66
19	240	4561-19	23,49

4510

Chiavi Combinate a Testa Poligonale Curvata



A mm	L mm	Part N°	€
6	110	4510-06	9,35
7	120	4510-07	9,43
8	130	4510-08	9,59
9	140	4510-09	10,02
10	150	4510-10	10,34
11	160	4510-11	11,09
12	170	4510-12	11,83
13	180	4510-13	12,83
14	190	4510-14	12,93
15	200	4510-15	15,31
16	210	4510-16	16,55
17	220	4510-17	17,10
18	230	4510-18	19,14
19	240	4510-19	20,06
20	250	4510-20	21,24
21	260	4510-21	22,08
22	270	4510-22	24,76
23	280	4510-23	26,73
24	290	4510-24	27,94
25	300	4510-25	29,83
26	310	4510-26	30,10
27	320	4510-27	32,10
28	330	4510-28	36,61
29	340	4510-29	39,07
30	350	4510-30	41,02
32	370	4510-32	42,89

4510

Supporto in Plastica

5
Pcs



8 • 10 • 13 • 17 • 19

Part N°	€
4510-014	78,17
450-011V *	14,85

* Supporto in Plastica Vuoto

4510

Supporto in Plastica

6
Pcs



8 • 10 • 12 • 13 • 14 • 17

Part N°	€
4510-016	82,87
450-011V *	14,85

* Supporto in Plastica Vuoto

4510

Supporto in Plastica

12
Pcs



8 • 9 • 10 • 11 • 12 • 13 • 14 • 15 • 16 • 17 • 18 • 19

Part N°	€
4510-022	175,03
450-017V *	23,51

* Supporto in Plastica Vuoto

Chiavi Fisse

Chiavi Poligonali Doppie Dritte



454

Chiavi Poligonali Doppie Dritte

CrV

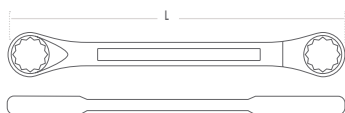

mm	mm	L mm	Part N°	€
6	7	120	454-06-07	7,80
8	9	135	454-08-09	8,07
10	11	150	454-10-11	8,96
12	13	165	454-12-13	9,78
13	17	210	454-13-17	10,40
14	15	185	454-14-15	10,73
16	17	210	454-16-17	11,53
17	19	225	454-17-19	11,98
18	19	225	454-18-19	11,98
20	22	240	454-20-22	13,86
21	23	255	454-21-23	17,91
24	26	270	454-24-26	21,57
24	27	270	454-24-27	21,57
25	28	285	454-25-28	22,79
27	29	315	454-27-29	27,48
30	32	335	454-30-32	28,90

454

Vaschetta Modulare

8
Pcs

CrV



1/4 (375 x 140 x 30 mm)



Part N°	€
454-080	91,96

Per maggiori informazioni sullo stoccaggio e vaschette modulari consulti le pagine:

20 • 35

454

Supporto in Plastica

6
Pcs

CrV



• 6x7 • 8x9 • 10x11 • 12x13 • 14x15 • 16x17

Part N°	€
454-016	65,12
450-011V *	14,85

* Supporto in Plastica Vuoto

454

Supporto in Plastica

8
Pcs

CrV



• 6x7 • 8x9 • 10x11 • 12x13 • 14x15 • 16x17 • 18x19 • 20x22

Part N°	€
454-018	90,96
450-013V *	17,31

* Supporto in Plastica Vuoto

454

Supporto in Plastica

10
Pcs

CrV



• 6x7 • 8x9 • 10x11 • 12x13 • 14x15 • 16x17 • 18x19
• 20x22 • 21x23 • 24x27

Part N°	€
454-020	130,44
450-015V *	22,26

* Supporto in Plastica Vuoto

454

Supporto in Plastica

12
Pcs

CrV



• 6x7 • 8x9 • 10x11 • 12x13 • 14x15 • 16x17 • 18x19
• 20x22 • 21x23 • 24x27 • 25x28 • 27x29

Part N°	€
454-022	180,70
450-017V *	23,51

* Supporto in Plastica Vuoto

Chiavi Fisse

Serie di Chiavi Poligonali Doppie Dritte



454

Busta in Nylon

8
Pcs

CrV



390 x 380 mm



- 6x7
- 8x9
- 10x11
- 12x13
- 14x15
- 16x17
- 18x19
- 20x22

Part N°	€
454-001	88,96
454-001V *	19,38

* Busta in Nylon Vuota

454

Busta in Nylon

10
Pcs

CrV



620 x 480 mm



- 6x7
- 8x9
- 10x11
- 12x13
- 14x15
- 16x17
- 18x19
- 20x22
- 21x23
- 24x26

Part N°	€
454-002	128,44
454-002V *	21,59

* Busta in Nylon Vuota

454

Busta in Nylon

12
Pcs

CrV



620 x 480 mm



- 6x7
- 8x9
- 10x11
- 12x13
- 14x15
- 16x17
- 18x19
- 20x22
- 21x23
- 24x26
- 25x28
- 30x32

Part N°	€
454-003	182,12
454-003V *	22,47

* Busta in Nylon Vuota

4554

Chiavi Poligonali Doppie Dritte Lunghe



A mm	L mm	Part N°	€
8 x 10	235	4554-08-10	31,88
10 x 12	290	4554-10-12	35,31
12 x 14	328	4554-12-14	38,77
13 x 15	328	4554-13-15	44,72
13 x 17	390	4554-13-17	45,74
16 x 18	404	4554-16-18	47,59
17 x 19	404	4554-17-19	49,33
22 x 24	435	4554-22-24	63,71

477

Chiavi TORX® (E) Doppie Dritte

Cr-V



		L mm	Part N°	€
E6	E8	130	477-E6-E8	12,14
E10	E12	144	477-E10-E12	13,39
E14	E18	180	477-E14-E18	15,75
E20	E24	220	477-E20-E24	18,46

Chiavi Fisse

Chiavi Poligonali Doppie Curvate



453

Chiavi Poligonali Doppie Curvate

CrV

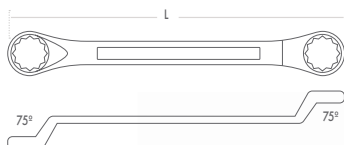

SAE

mm	mm	L mm	Part N°	€
6	7	170	453-06-07	10,09
8	9	183	453-08-09	11,04
8	10	183	453-08-10	11,66
10	11	197	453-10-11	11,74
10	12	198	453-10-12	12,89
12	13	212	453-12-13	12,90
12	14	214	453-12-14	14,54
13	15	222	453-13-15	16,70
13	17	242	453-13-17	16,38
14	15	230	453-14-15	13,58
16	17	245	453-16-17	16,17
17	19	270	453-17-19	18,73
18	19	275	453-18-19	18,78
19	22	315	453-19-22	21,99
20	22	318	453-20-22	22,20
21	23	327	453-21-23	24,34
22	24	327	453-22-24	25,88
24	26	340	453-24-26	30,15
24	27	340	453-24-27	30,40
25	28	347	453-25-28	35,10
27	29	351	453-27-29	36,86
27	30	351	453-27-30	38,93
30	32	365	453-30-32	42,79
32	36	415	453-32-36	65,64
36	41	450	453-36-41	92,56
41	46	506	453-41-46	132,24
46	50	526	453-46-50	146,79

		L mm	Part N°	€
1/4"	5/16"	170	453-1/4-5/16	11,49
5/16"	3/8"	183	453-5/16-3/8	11,92
3/8"	7/16"	197	453-3/8-7/16	12,81
7/16"	1/2"	212	453-7/16-1/2	13,82
1/2"	9/16"	222	453-1/2-9/16	13,93
9/16"	5/8"	245	453-9/16-5/8	15,29
5/8"	11/16"	246	453-5/8-11/16	17,38
11/16"	3/4"	275	453-11/16-3/4	22,87
13/16"	7/8"	318	453-13/16-7/8	23,26
7/8"	15/16"	327	453-7/8-15/16	30,63
15/16"	1"	340	453-15/16-1	32,26
1"	1.1/8"	347	453-1-1.1/8	37,92
1.1/16"	1.1/4"	365	453-1.1/16-1.1/4	41,24
1.1/8"	1.1/4"	370	453-1.1/8-1.1/4	49,31

453

Busta in Nylon

6
Pcs

CrV



350 x 330 mm

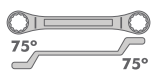

• 6x7 • 8x9 • 10x11 • 12x13 • 14x15 • 16x17

Part N°	€
453-001	81,77
453-001V *	19,73

* Busta in Nylon Vuota

453

Busta in Nylon

8
Pcs

CrV



390 x 380 mm

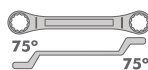

• 6x7 • 8x9 • 10x11 • 12x13 • 14x15
• 16x17 • 18x19 • 20x22

Part N°	€
453-002	122,75
453-002V *	21,03

* Busta in Nylon Vuota

453

Busta in Nylon

12
Pcs

CrV



620 x 480 mm

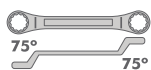

• 6x7 • 8x9 • 10x11 • 12x13 • 14x15 • 16x17
• 18x19 • 20x22 • 21x23 • 24x27 • 25x28 • 30x32

Part N°	€
453-003	255,37
453-003V *	24,38

* Busta in Nylon Vuota

453

Busta in Nylon

14
Pcs

CrV



620 x 600 mm

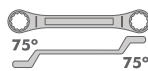

• 6x7 • 8x9 • 10x11 • 12x13 • 14x15
• 16x17 • 18x19 • 20x22 • 21x23 • 24x26
• 25x28 • 30x32 • 32x36 • 36x41

Part N°	€
453-004	417,08
453-004V *	25,68

* Busta in Nylon Vuota

Chiavi Fisse

Serie di Chiavi Poligonali Doppie Curvate



453

Busta in Nylon

7
Pcs

SAE

CrV



390 x 380 mm



- 1/4" x 5/16" • 5/16" x 3/8" • 3/8" x 7/16"
- 7/16" x 1/2" • 1/2" x 9/16" • 5/8" x 11/16"
- 11/16" x 3/4"

Part N°	€
453-005	110,46
453-005V *	20,84

* Busta in Nylon Vuota

453

Busta in Nylon

10
Pcs

SAE

CrV



620 x 480 mm

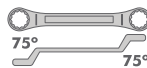

- 1/4" x 5/16" • 5/16" x 3/8" • 3/8" x 7/16"
- 7/16" x 1/2" • 1/2" x 9/16" • 9/16" x 5/8"
- 5/8" x 11/16" • 13/16" x 7/8" • 15/16" x 1"
- 1.1/16" x 1.1/4"

Part N°	€
453-006	199,64
453-006V *	24,07

* Busta in Nylon Vuota

453

Scatola di Cartone

8
Pcs

CrV

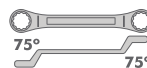

- 6x7 • 8x9 • 10x11 • 12x13 • 14x15
- 16x17 • 18x19 • 20x22

Part N°	€
453-018	124,75

453

Supporto in Plastica

6
Pcs

CrV



• 8x9 • 10x11 • 12x13 • 14x15 • 16x17 • 18x19

Part N°	€
453-016	92,46
450-011V *	14,85

* Supporto in Plastica Vuoto

453

Supporto in Plastica

6
Pcs

CrV

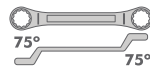

• 6x7 • 8x9 • 10x11 • 12x13 • 14x15 • 16x17

Part N°	€
453-016-2	83,77
450-011V *	14,85

* Supporto in Plastica Vuoto

453

Vaschetta Modulare

6
Pcs

CrV



1/3 (375 x 188 x 30 mm)

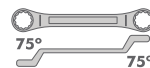

• 8x9 • 10x11 • 12x13 • 14x15 • 16x17 • 18x19

Part N°	€
453-080	96,71

Per maggiori informazioni sullo stoccaggio e vaschette modulari consulti le pagine:

20 • 35

Chiavi Poligonali Doppie a Mezzaluna

473

Chiavi Poligonali Doppie a Mezzaluna

CrV



mm	mm	L mm	Part N°	€
11	13	149	473-11-13	12,27
14	17	170	473-14-17	13,82
15	16	170	473-15-16	13,87
15	17	170	473-15-17	13,87
19	22	227	473-19-22	17,73

Chiavi Fisse

Chiavi per Raccordi



483

Chiavi Poligonale Doppie per Raccordi

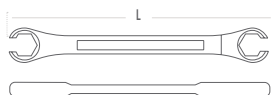

mm	L mm	Part N°	€
8 x 10	131	483-08-10	13,72
9 x 11	151	483-09-11	13,81
10 x 11	152	483-10-11	14,37
10 x 12	152	483-10-12	14,91
12 x 13	168	483-12-13	15,36
12 x 14	177	483-12-14	16,12
14 x 15	177	483-14-15	16,12
14 x 17	194	483-14-17	16,12
17 x 19	214	483-17-19	22,01
19 x 22	235	483-19-22	22,01
22 x 24	255	483-22-24	25,20
24 x 27	273	483-24-27	31,86
30 x 32	292	483-30-32	39,44

485

Chiavi Poligonali a Cricchetto per Racordi



mm	L mm	A mm	B mm	Part N°	€
10	156	32	7	485-10	27,89
11	156	32	7	485-11	27,89
12	156	32	7	485-12	27,89
13	156	32	7	485-13	27,89
14	156	32	7	485-14	27,89
17	210	35	8	485-17	33,96
19	210	37	8	485-19	33,96
22	220	41	11	485-22	37,39
24	220	41	11	485-24	40,91
27	318	49	13	485-27	58,01
32	320	54	17,8	485-32	63,77

483

Supporto in Plastica

6
Pcs

CrV



Part N°	€
483-016	111,28
450-011V *	14,85

* Supporto in Plastica Vuoto

457

Chiavi Combinate a Cricchetto Reversibile

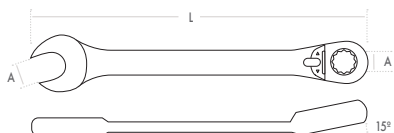

A mm	L mm	Part N°	€
6	120	457-06	16,42
7	120	457-07	16,42
8	134	457-08	16,42
9	158	457-09	17,37
10	158	457-10	18,18
11	164	457-11	18,48
12	167	457-12	19,12
13	177	457-13	20,20
14	189	457-14	21,78
15	198	457-15	23,06
16	204	457-16	22,65
17	224	457-17	24,49
18	245	457-18	24,98
19	245	457-19	25,94
20	280	457-20	31,77
21	280	457-21	34,37
22	280	457-22	36,52
23	320	457-23	47,20
24	310	457-24	40,34
25	320	457-25	57,47
26	320	457-26	67,76
27	330	457-27	70,99
28	355	457-28	78,89
29	355	457-29	80,00
30	425	457-30	83,98
31	425	457-31	90,15
32	425	457-32	90,46
33	425	457-33	94,67
36	445	457-36	173,75

Chiavi a Cricchetto

Serie di Chiavi Combinate a Cricchetto Reversibile



457

Busta in Nylon

457

Supporto in Plastica

7
Pcs

CrV

72^(5°)



330 x 390 mm

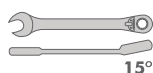

10 • 12 • 13 • 14 • 15 • 17 • 19

15°

Part N°	€
457-001	159,00
457-001V *	15,75

* Busta in Nylon Vuota

5
Pcs

CrV

72^(5°)

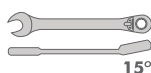

10 • 12 • 13 • 14 • 15

15°

Part N°	€
457-015	110,58
450-011V *	14,85

* Supporto in Plastica Vuoto

5
Pcs

CrV

72^(5°)

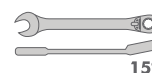

8 • 10 • 13 • 17 • 19

15°

Part N°	€
457-014	113,47
450-011V *	14,85

* Supporto in Plastica Vuoto

457

Supporto in Plastica

6
Pcs

CrV

72^(5°)

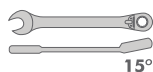

8 • 10 • 12 • 13 • 14 • 17

15°

Part N°	€
457-016	128,43
450-011V *	14,85

* Supporto in Plastica Vuoto

7
Pcs

CrV

72^(5°)

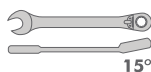

10 • 12 • 13 • 14 • 15 • 17 • 19

15°

Part N°	€
457-017	161,00
455-012V *	12,05

* Supporto in Plastica Vuoto

8
Pcs

CrV

72^(5°)



8 • 10 • 11 • 12 • 13 • 14 • 17 • 19

15°

Part N°	€
457-018	172,85
450-013V *	17,31

* Supporto in Plastica Vuoto

457

Supporto in Plastica

12

Pcs

CrV

72



8 • 9 • 10 • 11 • 12 • 13
14 • 15 • 16 • 17 • 18 • 19

Part N°

€

457-020

260,90

450-017V *

23,51

* Supporto in Plastica Vuoto

457

Scatola di Cartone

5

Pcs

CrV

72



10 • 12 • 13 • 14 • 15

Part N°

€

457-035

110,58

6

Pcs

CrV

72

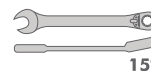

10 • 12 • 13 • 14 • 15 • 17

Part N°

€

457-036

135,07

457

Scatola di Cartone

6

Pcs

CrV

72



10 • 11 • 13 • 14 • 15 • 17

Part N°

€

457-046

134,43

8

Pcs

CrV

72



8 • 10 • 12 • 13 • 14 • 15 • 17 • 19

Part N°

€

457-038

177,43

457

Vaschetta Modulare

7

Pcs

CrV

72

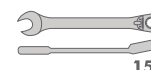

8 • 10 • 13 • 15 • 17 • 19 • 22

Part N°

€

457-081

177,30

10

Pcs

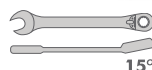

10 • 12 • 13 • 14
15 • 17 • 19

1/4" • 3/8" • 1/2"

Part N°

€

457-080

191,50 *

Per maggiori informazioni sullo stoccaggio e vaschette modulari consulti le pagine:

20 • 35

* Fino ad esaurimento scorte

Chiavi a Cricchetto

Chiavi Combinate a Cricchetto Dritte

DOGHER
®TOOLS

4557

Chiavi Combinate a Cricchetto Dritte

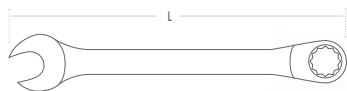

mm	L mm	Part N°	€
6	130	4557-06	14,69
7	130	4557-07	14,79
8	140	4557-08	11,98
9	150	4557-09	11,98
10	160	4557-10	13,15
11	165	4557-11	14,40
12	172	4557-12	15,19
13	177	4557-13	16,20
14	191	4557-14	16,91
15	199	4557-15	18,31
16	209	4557-16	19,72
17	225	4557-17	20,65
18	237	4557-18	21,12
19	248	4557-19	21,55
20	248	4557-20	25,01
21	289	4557-21	30,03
22	289	4557-22	32,38
24	320	4557-24	36,29
27	364	4557-27	55,98
30	423	4557-30	67,89
32	423	4557-32	71,69

4557

Supporto in Plastica

6
Pcs

CrV



 • 8 • 10 • 11 • 12 • 13 • 17

Part N°	€
4557-016	99,82
450-011V *	14,85

* Supporto in Plastica Vuoto

4557

Supporto in Plastica

8
Pcs

CrV



 • 8 • 10 • 11 • 12 • 13 • 14 • 17 • 19

Part N°	€
4557-018	138,27
450-013V *	17,31

* Supporto in Plastica Vuoto

4557

Supporto in Plastica

10
Pcs

CrV



 • 8 • 9 • 10 • 11 • 12 • 13 • 14
• 15 • 16 • 17

Part N°	€
4557-020	166,74
450-015V *	22,26

* Supporto in Plastica Vuoto

4557

Supporto in Plastica

12
Pcs

CrV



 • 8 • 9 • 10 • 11 • 12 • 13 • 14
• 15 • 16 • 17 • 18 • 19

Part N°	€
4557-022	209,40
450-017V *	23,51

* Supporto in Plastica Vuoto

Chiavi a Cricchetto

Chiavi Combinate a Cricchetto Reversibile Corte



459

Chiavi Combinate a Cricchetto Reversibile Corte

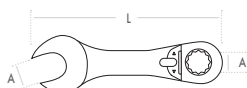

A mm	L mm	Part N°	€
8	93	459-08	16,94
10	95	459-10	17,17
13	106	459-13	18,39
17	125	459-17	22,37
19	138	459-19	25,45

Serie di Chiavi Combinate a Cricchetto Reversibile Corte

459

Supporto in Plastica

5

Pcs



• 8 • 10 • 13 • 17 • 19

Part N°	€
459-015	108,56
459-010V *	18,91

* Supporto in Plastica Vuoto

475

Chiavi Poligonali Quadrupla a Doppio Cricchetto Reversibile

CrV

72^{5°}

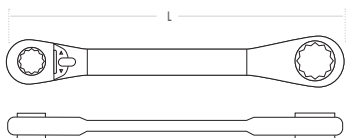

mm	mm	L mm	Part N°	€
8x10	12x13	165	475-08-13	31,24
9x11	14x15	180	475-09-15	37,21
10x13	17x19	204	475-10-19	42,10
13x15	17x19	225	475-13-19	39,47
16x17	18x19	225	475-16-19	42,10

Serie di Chiavi Poligonali Quadrupla a Doppio Cricchetto Reversibile

475

Busta in Nylon

3

Pcs

CrV

72^{5°}



220 x 330 mm



- 8x10 12x13
- 9x11 14x15
- 16x17 18x19

Part N°	€
475-001	120,80
475-001 V *	14,08

* Busta in Nylon Vuota

Chiavi a Cricchetto

Chiavi Combinate a Cricchetto Snodate

DOGHER
TOOLS

458

Chiavi Combinate a Cricchetto Snodate

CrV

72°^{5°}

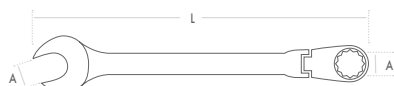

A mm	L mm	Part N°	€
6	136	458-06	21,02
7	136	458-07	18,92
8	136	458-08	21,34
9	150	458-09	22,60
10	158	458-10	24,78
11	175	458-11	26,08
12	175	458-12	26,76
13	185	458-13	27,14
14	193	458-14	28,73
15	215	458-15	29,63
16	215	458-16	30,53
17	231	458-17	32,92
18	249	458-18	33,80
19	249	458-19	36,13
20	280	458-20	47,49
21	280	458-21	48,71
22	280	458-22	46,91
24	310	458-24	53,50

458

Supporto in Plastica

5
Pcs

CrV

72^{5ª}



8 • 10 • 13 • 17 • 19

Part N°	€
458-015	150,56
450-011V *	14,85

* Supporto in Plastica Vuoto

458

Supporto in Plastica

8
Pcs

CrV

72^{5ª}



8 • 10 • 11 • 12 • 13 • 14 • 17 • 19

Part N°	€
458-018	232,13
450-013V *	17,31

* Supporto in Plastica Vuoto

458

Scatola di Cartone

5
Pcs

CrV

72^{5ª}



8 • 10 • 13 • 17 • 19

Part N°	€
458-035	150,56

6
Pcs

CrV

72^{5ª}



10 • 12 • 13 • 14 • 15 • 17

Part N°	€
458-036	178,22

8
Pcs

CrV

72^{5ª}



8 • 10 • 12 • 13 • 14 • 15 • 17 • 19

Part N°	€
458-038	235,68

Chiavi a Cricchetto

Chiavi Doppie a Cricchetto Dritte



456

Chiavi Doppie a Cricchetto Dritte

CrV

72^{5°}

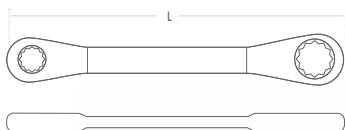

mm	mm	L mm	Part N°	€
6	7	115	456-06-07	19,40
7	8	115	456-07-08	19,40
8	9	130	456-08-09	19,40
10	11	145	456-10-11	21,49
12	13	166	456-12-13	27,17
13	17	181	456-13-17	27,32
14	15	181	456-14-15	28,23
16	18	205	456-16-18	30,53
17	19	225	456-17-19	31,40
20	22	255	456-20-22	48,62

Serie di Chiavi Doppie a Cricchetto Dritte

456

Supporto in Plastica

5
Pcs

CrV

72^{5°}



Part N°	€
456-015	123,94
450-011V *	14,85

* Supporto in Plastica Vuoto

456

Scatola di Cartone

5
Pcs

CrV

72^{5°}



• 8x9 • 10x11 • 12x13 • 14x15 • 16x18

Part N°

€

456-035

135,07

456

Scatola di Cartone

6
Pcs

CrV

72^{5°}



• 8x9 • 10x11 • 12x13 • 14x15 • 16x18 • 17x19

Part N°

€

456-036

166,47

Chiavi Doppie a Cricchetto TORX® Dritte

474

Chiavi Doppie a Cricchetto TORX® (E) Dritte

CrV

72^{5°}



		L mm	Part N°	€
E6	E8	130	474-E6-E8	22,77
E10	E12	144	474-E10-E12	23,82
E14	E18	180	474-E14-E18	29,43
E20	E24	220	474-E20-E24	35,28

Chiavi a Cricchetto

Chiavi Doppie a Cricchetto Reversibile Curvate



455

Chiavi Doppie a Cricchetto Reversibile Curvate

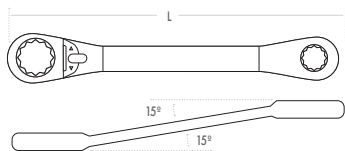

SAE

mm	mm	L mm	Part N°	€
6	7	115	455-06-07	29,78
8	9	130	455-08-09	29,78
8	10	130	455-08-10	29,78
10	11	145	455-10-11	31,52
10	12	145	455-10-12	31,52
10	13	145	455-10-13	33,78
12	13	166	455-12-13	34,80
12	14	166	455-12-14	34,80
14	15	180	455-14-15	35,20
14	17	180	455-14-17	38,72
16	17	205	455-16-17	38,72
16	18	205	455-16-18	38,72
17	19	225	455-17-19	47,39

		L mm	Part N°	€
1/4"	5/16"	115	455-1/4-5/16	28,37
3/8"	7/16"	145	455-3/8-7/16	35,85
1/2"	9/16"	166	455-1/2-9/16	33,84

455

Busta in Nylon

6

Pcs

CrV



300 x 390 mm

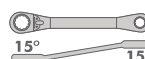

• 8x9 • 10x11 • 12x13 • 14x15 • 16x18 • 17x19

Part N°	€
455-001	223,65
455-001V *	16,03

* Busta in Nylon Vuota

455

Scatola di Cartone

5

Pcs

CrV

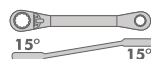

• 8x9 • 10x11 • 12x13 • 14x15 • 16x18

Part N°	€
455-035	178,27

455

Scatola di Cartone

6

Pcs

CrV

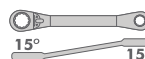

• 8x9 • 10x11 • 12x13 • 14x15 • 16x18 • 17x19

Part N°	€
455-036	225,65

455

Supporto in Plastica

5
Pcs

CrV

72^{5°}

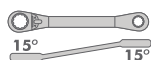

• 8x9 • 10x11 • 12x13 • 14x15 • 16x18

Part N°	€
455-015	178,27
450-011V *	14,85

* Supporto in Plastica Vuoto

455

Supporto in Plastica

7
Pcs

CrV

72^{5°}

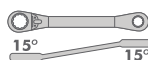

• 6x7 • 8x9 • 10x11 • 12x13 • 14x15 • 16x18 • 17x19

Part N°	€
455-017	255,43
455-012V *	12,05

* Supporto in Plastica Vuoto

455

Vaschetta Modulare

9
Pcs

CrV

72^{5°}



1/3 (375 x 188 x 30 mm)

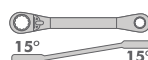

• 8x9 • 10x11 • 12x13 • 14x15 • 16x18 • 17x19



• 1/4" • 3/8" • 1/2"

Part N°	€
455-080	256,15

Per maggiori informazioni sulle vaschette modulari p. 20 • 35

Accessori per Chiavi a Cricchetto

476

Quadri di Attacco

CrV



□	○ mm	Part N°	€
1/4"	10	476-1/4-10	7,70
3/8"	13	476-3/8-13	8,56
1/2"	19	476-1/2-19	10,00
3/4"	32	476-3/4-32	19,94

476

Portainseri

CrV



○	○ mm	Part N°	€
1/4"	10	476-1/4P-10	2,89
5/16"	13	476-5/16P-13	4,84
10 mm	19	476-10P-19	5,86

Chiavi Fisse

Chiavi a Tubo Doppie Leggere



461

Chiavi a Tubo Doppie Leggere

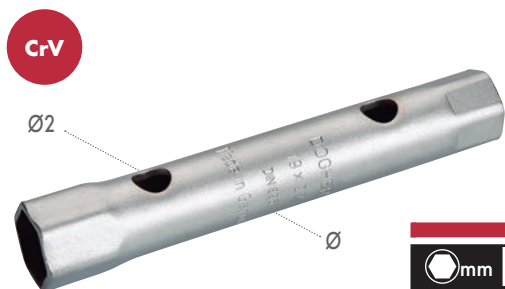

Spina

mm	mm	L mm	Ø mm	Ø2 mm	Part N°	€	L mm	Ø mm	Part N°	€				
6	7	110	12	7	461-06-07	6,91	131,5	6,5	460-04	5,17				
8	9	110	14	7	461-08-09	8,14								
8	10	120	13	6	461-08-10	7,93	131,5	5,5	460-03	3,70				
9	10	120	13	6	461-09-10	8,39								
10	11	130	17	8	461-10-11	8,89	131,5	7,5	460-05	6,49				
10	13	140	15	8	461-10-13	9,32								
11	13	140	15	8	461-11-13	9,40								
12	13	140	17	8	461-12-13	9,61								
12	14	143	17	8	461-12-14	10,70								
13	14	144	17	8	461-13-14	10,70								
13	15	142	17	8	461-13-15	10,81								
13	17	149	20	10	461-13-17	10,92					131,5	9,5	460-06	7,82
14	15	140	19	8	461-14-15	9,37					131,5	7,5	460-05	6,49
14	17	149	20	10	461-14-17	10,70					131,5	9,5	460-06	7,82
16	17	150	21	8	461-16-17	10,37	131,5	7,5	460-05	6,49				
17	19	157	24	10	461-17-19	11,83	131,5	9,5	460-07	9,15				
18	19	160	22	8	461-18-19	12,41	131,5	7,5	460-05	6,49				
19	22	169	26	12	461-19-22	13,72	131,5	11,5	460-07	9,15				
20	22	170	25,5	8	461-20-22	14,01	131,5	7,5	460-05	6,49				
21	23	170	25,5	8	461-21-23	15,71								
22	24	184	33	14	461-22-24	17,20	131,5	12,5	460-08	11,50				
24	26	190	32	8	461-24-26	16,98	131,5	7,5	460-05	6,49				
24	27	183	30	14	461-24-27	20,41	131,5	12,5	460-08	11,50				
25	28	190	32	8	461-25-28	20,49	131,5	7,5	460-05	6,49				
27	29	195	32	8	461-27-29	22,58								
27	30	198	35	18	461-27-30	24,08	250	13,6	543-015	17,62				
27	32	196	35	18	461-27-32	24,08	250	13,6	543-015	17,62				
30	32	210	32	8	461-30-32	22,58	131,5	7,5	460-05	6,49				
36	38	165	42,5	10	461-36-38	22,84	131,5	9,5	460-06	7,82				
36	41	221	45	18	461-36-41	40,23	500	18	460-10	26,36				
41	46	237	50	18	461-41-46	45,63								
46	50	238	54	18	461-46-50	67,35								
50	55	238	60	18	461-50-55	160,27								

• Altre barre compatibili:

L mm	Ø mm	Part N°	€
115	7,5	509-015	6,32
200	11	524-015	13,00
250	13,6	543-015	17,62

461

Busta in Nylon

8

Pcs

CrV



380 x 400 mm



- 6x7
- 8x9
- 10x11
- 12x13
- 14x15
- 16x17
- 18x19
- 20x22

Part N°	€
461-001	85,96
461-001V *	19,94

* Busta in Nylon Vuota

461

Busta in Nylon

12

Pcs

CrV



520 x 390 mm



- 6x7
- 8x9
- 10x11
- 12x13
- 14x15
- 16x17
- 18x19
- 20x22
- 21x23
- 24x26
- 25x28
- 30x32

Part N°	€
461-002	165,71
461-002V *	21,90

* Busta in Nylon Vuota

Chiavi Fisse

Chiavi a Tubo Doppie Pesanti e Spine di Manovra



460

Chiavi a Tubo Doppie Pesanti

CrV



mm	mm	L mm	mm	Part N°	€
6	7	105	8	460-06-07	14,68
8	9	110	8,6	460-08-09	11,89
10	11	120	11	460-10-11	12,59
12	13	140	13	460-12-13	14,77
14	15	145	14	460-14-15	16,55
16	17	155	16	460-16-17	19,28
18	19	165	18	460-18-19	23,05
20	22	170	20	460-20-22	26,27
21	23	185	21	460-21-23	29,22
24	26	190	24	460-24-26	37,86
25	28	205	25	460-25-28	43,46
27	29	210	27	460-27-29	53,95
30	32	210	30	460-30-32	58,41

460

Spine di Manovra
Per Chiave a Tubo Doppie



Ø mm	mm	mm	Part N°	€
2,5	6	7	460-01	2,22
	8	9		
4,5	10	11	460-02	3,40
	12	13		
5,5	14	15	460-03	3,70
	16	17		
6,5	18	19	460-04	5,17
	20	22		
7,5	21	23	460-05	6,49
	24	26		
9,5	25	28	460-06	7,82
	27	29		
11,5	30	32	460-07	9,15
	30	32		
12,5	30	32	460-08	11,50
	30	32		

Serie di Chiavi a Tubo Doppie Pesanti

460

Vaschetta Modulare

8
Pcs

CrV



1/4 (375 x 140 x 30 mm)



• 6x7 • 8x9 • 10x11 • 12x13 • 14x15
• 16x17 • 18x19 • 20x22

Part N°	€
460-080	148,32

Per maggiori informazioni sulle vaschette modulari

p. 20 • 35

460

Busta in Nylon

6
Pcs

CrV



330 x 350 mm



• 6x7 • 8x9 • 10x11 • 12x13 • 14x15 • 16x17

Part N°	€
460-001	96,00
460-001V *	17,66

* Busta in Nylon Vuota

460

Busta in Nylon

8
Pcs

CrV



430 x 380 mm



• 6x7 • 8x9 • 10x11 • 12x13 • 14x15 • 16x17
• 18x19 • 20x22

Part N°	€
460-002	145,32
460-002V *	19,39

* Busta in Nylon Vuota

460

Busta in Nylon

10
Pcs

CrV



480 x 380 mm



• 6x7 • 8x9 • 10x11 • 12x13 • 14x15 • 16x17
• 18x19 • 20x22 • 21x23 • 24x26

Part N°	€
460-003	214,41
460-003V *	19,39

* Busta in Nylon Vuota

460

Busta in Nylon

12
Pcs

CrV



520 x 390 mm



• 6x7 • 8x9 • 10x11 • 12x13 • 14x15 • 16x17
• 18x19 • 20x22 • 21x23 • 24x26 • 25x28 • 30x32

Part N°	€
460-004	317,28
460-004V *	21,30

* Busta in Nylon Vuota

Chiavi Fisse

Chiavi a Pipa Doppie



462

Chiavi a Pipa Doppie

CrV



mm	L mm	Part N°	€
6	110	462-06	8,03
7	114	462-07	8,32
8	120	462-08	8,54
9	125	462-09	8,54
10	131	462-10	9,02
11	137	462-11	9,19
12	144	462-12	10,53
13	153	462-13	10,59
14	160	462-14	11,39
15	174	462-15	12,37
16	185	462-16	13,03
17	197	462-17	13,55
18	211	462-18	14,85
19	218	462-19	16,56
20	222	462-20	18,74
21	231	462-21	19,97
22	247	462-22	20,76
23	255	462-23	20,79
24	266	462-24	24,30
25	278	462-25	36,59
26	289	462-26	41,53
27	299	462-27	45,33
28	310	462-28	51,04
29	319	462-29	51,65
30	332	462-30	61,15
32	353	462-32	63,84

462

Vaschetta Modulare

11
Pcs

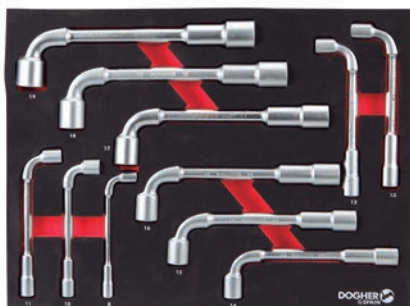

• 8 • 10 • 11 • 12 • 13 • 14
• 15 • 16 • 17 • 18 • 19

Part N°	€
462-080	149,61

1/2 (375 x 280 x 30)

Per maggiori informazioni sulle vaschette modulari

p. 20 • 35

462

Supporto in Plastica

5
Pcs

CrV



Part N°	€
462-010	60,48

462

Supporto in Plastica

10
Pcs

CrV



Part N°	€
462-011	113,96

462

Busta in Nylon

6
Pcs

CrV



190 x 280 mm



Part N°	€
462-001	77,69
462-001V *	17,66

* Busta in Nylon Vuota

462

Busta in Nylon

10
Pcs

CrV



Part N°	€
462-003	120,30
462-003V *	19,02

* Busta in Nylon Vuota

Chiavi Fisse

Chiavi a Bussola Sonodate e per Route



467

Chiavi a Bussola Snodate con Bocca Poligonale

CrV



mm	mm	L mm	Part N°	€
6	7	195	467-06-07	19,07
8	9	195	467-08-09	19,07
10	11	210	467-10-11	19,65
12	13	225	467-12-13	23,34
14	15	245	467-14-15	26,22
16	17	260	467-16-17	30,03
18	19	275	467-18-19	34,90
20	22	300	467-20-22	44,00
21	23	300	467-21-23	45,92
24	27	325	467-24-27	50,84

467

Vaschetta Modulare

6 Pcs

CrV



1/3 (375 x 188 x 30 mm)

• 8x9 • 10x11 • 12x13 • 14x15 • 16x17 • 18x19

Part N°	€
467-080	165,71

Per maggiori informazioni sullo stoccaggio e vaschette modulari consulti le pagine:

20 • 35

465

Chiavi per Ruota

CrV

1/2"



mm	L mm	Part N°	€
1/2"	300	465-1/2-300	15,75

CrV

3/4"



mm	L mm	Part N°	€
3/4"	300	465-3/4-300	24,99
3/4"	450	465-3/4-450	33,38

467

Busta in Nylon

7 Pcs

CrV



330 x 390 mm

• 8x9 • 10x11 • 12x13 • 14x15 • 16x17
• 18x19 • 20x22

Part N°	€
467-001	203,45
467-001V *	19,58

* Busta in Nylon Vuota

466

Chiavi a Croce

CrV

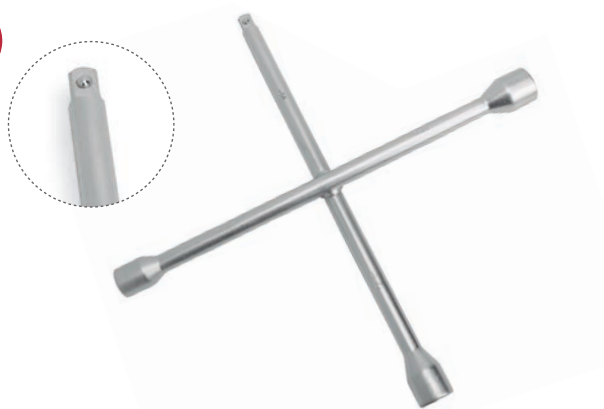

□	mm	L mm	Part N°	€
1/2"	17x19x22	375	466-1/2-375	31,24
3/4"	24x27x32	625	466-3/4-625	91,85

468

Chiavi a T Snodate per Candele

CrV



mm	L mm	Part N°	€
16	300	468-16-300	31,92
18	300	468-18-300	32,92
21	300	468-21-300	33,15

469

Chiavi a T Snodate con Bocca Esagonale

CrV



mm	L mm	Part N°	€
6	390	469-06-390	31,03
8	390	469-08-390	27,92
10	500	469-10-500	31,11
12	500	469-12-500	31,11
13	500	469-13-500	31,11
17	500	469-17-500	35,21
19	500	469-19-500	39,32

Chiavi Fisse

Chiavi a Croce Universali



470

Chiave a Croce Universale per Cabine Acqua, Gas ed Elettricità

6-8 mm

PH2

7 mm

9 mm

9 mm

Adapt.1/4"

Part N°	€
470-001	20,42



· Realizzato in Zamak. Per installazioni tecniche in edifici, in impianti di condizionamento e ventilazione, valvole di intercettazione, quadri elettrici principali, ecc ...

EXP

Espositore di Chiavi a Croce Universali per Cabine Acqua, Gas ed Elettricità



12
Pcs

470-001 (x12)

Part N°	€
470-001J	245,07

230 x 210 x 155 mm

470

Chiave a Croce Universale per Cabine Riscaldamento ed Aria Condizionata

6-8 mm

PH2

Adapt. 1/4"

10 mm

9 mm

7 mm



Part N°	€
470-002	20,79

· Realizzato in Zamak. Per installazioni tecniche in edifici, in impianti di condizionamento e ventilazione, valvole di intercettazione, quadri elettrici principali, ecc ...

Chiavi a Settore Snodate

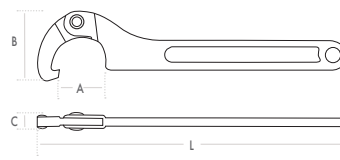

471

Chiavi a Settore Snodate con Nasello Quadro

CrV



 mm	L mm	Part N°	€
13~35	168	471-13-35	32,29
35~50	202	471-35-50	35,18
50~80	280	471-50-80	52,84
80~120	345	471-80-120	68,47
120~180	492	471-120-180	94,19

472

Chiavi a Settore Snodate con Nasello Tondo Intercambiabile

CrV



 mm	L mm	Part N°	€
13~35	168	472-13-35	35,13
35~50	202	472-35-50	38,83
50~80	280	472-50-80	54,37
80~120	345	472-80-120	72,98
120~180	492	472-120-180	97,67

472

Naselli Tondi di Ricambio

CrV



 mm	Ø mm	Part N°	€
13~35	3	472-0	2,92
35~50	4	472-1	3,86
50~80	5	472-2	5,43
80~120	6	472-3	6,91
120~180	8	472-4	9,05

471

Chiave a Settore Regolabile Snodata con Nasello Quadro

CrV



 mm	L mango	Part N°	€
120~325	600	471-120-325	398,37

472

Serie Chiavi a Settore Snodate con Nasello Tondo Intercambiabile



 mm	Part N°	€
20~100	472-001	156,83

Chiavi Fisse

Chiavi per Tappi di Carter



482

Chiave per Tappo di Carter

Cr-V

8 mm

10 mm

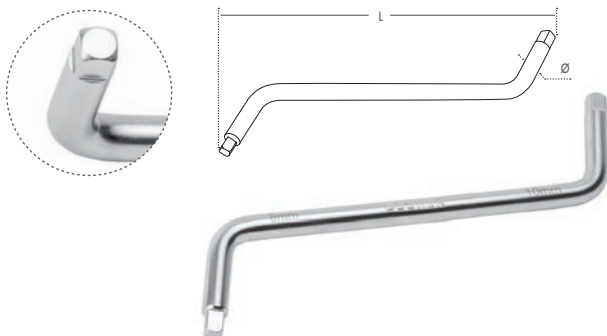

mm	mm	L mm	Ø mm	Part N°	€
8	10	255	12	482-001	11,94

• Per tappi dei filtri dell'olio e scatola di ricambio nei veicoli Citroën, Peugeot, Renault, Volvo...

482

Chiave Rinforzata per Tappo di Carter

Cr-V

8 mm

10 mm

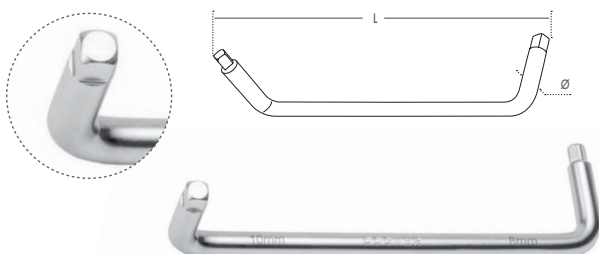

mm	mm	L mm	Ø mm	Part N°	€
8	10	235	13	482-002	19,18

• Per tappi dei filtri dell'olio e scatola di ricambio nei veicoli Citroën, Peugeot, Renault, Volvo...

482

Chiave Rinforzata a Bussola per Tappo di Carter

Cr-V

8 mm

11 mm

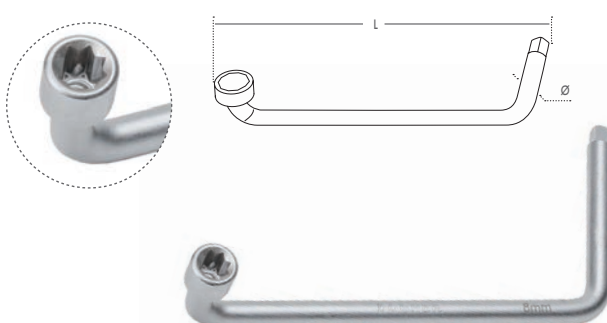

mm	mm	L mm	Ø mm	Part N°	€
8	11	250	12	482-003	21,90

• Per tappi dei filtri dell'olio e scatola di ricambio nei veicoli Citroën, Peugeot, Renault, Volvo...

480

Leve per Pneumatici



L mm	Part N°	€
215	480-215	8,36
350	480-350	14,45
380	480-380	22,51
500	480-500	24,72

466

Leve per Pneumatici



mm	Part N°	€
17	466-17	16,13
19	466-19	17,18
21	466-21	19,12
23	466-23	20,50

481

Pinza Regolabile per Filtri Olio



mm	Part N°	€
85-115	481-85-115	30,25

481

Chiavi a Nastro Metallico per Filtri Olio



mm	Part N°	€
65-105	481-65-105	25,88
110-165	481-110-165	27,50

• Per cambiare il nastro rimuovere la vite dalla base rotante.

481

Ricambi di Nastro



mm	Part N°	€
65-105	481-65-105R	7,65
110-165	481-110-165R	8,57

Adatto per
481-65-105 / 481-110-165

480

Set Utensili per Interni

11

Pcs



- Utensili per facilitare la rimozione di pannelli, cruscotti, modanature e altri accessori dall'interno delle automobili.
- Realizzati in plastica ad alta resistenza per una lunga durata.
- Prevengono possibili danni alle superfici e alle parti più morbide.



Part N°	€
480-011	42,26

Chiavi Fisse

Chiavi per Filtro Olio



481

Chiavi Snodate a Catena Per Filtri Olio



L mm (catena)	Ø mm	Part N°	€
350	60-105	481-010	56,95
520	60-160	481-011	84,70

Ricambio catena

481-010R	38,43
481-011R	46,13

481

Chiavi a Nastro per Filtri Olio



L mm (nastro)	Ø mm	Part N°	€
580	60-140	481-020	35,25
840	60-265	481-021	65,33

Ricambi di Nastro

481-020R	17,43
481-021R	21,88

481

Serie di Chiavi a Bussola per Filtri Olio

30
Pcs



Part N°	€
481-001	211,74

- 28 Chiavi a Bussola per Filtri Olio
- 1 Chiave per Filtro a 3 Bracci Regolabile 65-120 mm
- 1 Adattatore Riduttore da 1/2" a 3/8"

481

Chiavi a Bussola per Filtri Olio

CrV

DIN7444



	Ø mm	Part N°	€	
14	65	481-101	15,39	Daihatsu - Toyota - Nissan - Fiat
6	66	481-102	15,39	Fiat Punto 1.2 - Renault Clio 1.2 - Rapid - Twingo
14	65-67	481-103	15,39	Daihatsu - Toyota - Nissan - Fiat
14	68	481-104	15,39	Mazda - Ford - Subaru
14	73	481-105	15,39	Toyota - Lexus - Alfa Romeo
15	74	481-106	15,39	Audi - General Motors - Rover - Chrysler
15	74-76	481-107	15,39	Ford - Opel - VW, Audi - Mercedes-Benz - Chrysler
15	75-77	481-108	15,39	VW - Audi - Isuzu - Mercedes-Benz - Ford - Opel
8	76	481-109	15,39	Fiat Marea - Lancia Delta
12	76	481-110	15,39	Fiat - Mercedes-Benz - Renault
14	76	481-111	15,39	VW - Porsche - Mercedes-Benz - BMW, Audi - Opel
30	76	481-112	15,39	Ford - Motorcraft FL400A
15	78	481-113	15,39	Nissan - Ford - Toyota - Honda
15	80	481-114	15,39	Nissan - Honda - Opel - Mazda - Subaru - Toyota
15	80-82	481-115	15,39	Subaru - Toyota - Honda - Nissan - Mazda - Acura
16	86	481-116	15,39	Volvo
18	86	481-117	15,39	VW - Audi - Peugeot - Citroen - Renault
18	90	481-118	15,39	Honda - Mitsubishi - Isuzu - Subaru - Mazda
10	92	481-119	15,39	Fiat - Lancia
15	93	481-120	15,39	Mazda - Volvo - Mitsubishi - Nissan - Honda
36	93	481-121	15,39	Ford - Motorcraft FLINFLA 1B - FL3001 - FL320
45	93	481-122	15,39	VW - Audi
15	95	481-123	15,39	Toyota - Alfa Romeo - Ford - General Motors - Chrysler
18	96	481-124	15,39	Audi - VW - Renault
15	100	481-125	15,39	Isuzu - Mitsubishi
15	106	481-126	15,39	Fiat - Scania - MAN
15	108	481-127	15,39	Volvo Diesel C70 - S70 - N70 - 850 TDI
18	108	481-128	15,39	Daihatsu - Toyota - Nissan - Fiat

905

Chiavi Snodate 3 Bracci Regolabile

3/8"



Ø mm	Part N°	€
65-120	905-020	20,33

Chiavi Fisse

Chiavi a Percussione

DOGHER
TOOLS

452

Chiavi Poligonali Semplici a Percussione

CrV

DIN7444



mm	L mm	Part N°	€
17	146	452-17	26,79
19	147	452-19	26,92
22	152	452-22	27,47
24	163	452-24	27,99
27	180	452-27	30,96
30	190	452-30	35,23
32	190	452-32	37,87
36	205	452-36	43,74
41	230	452-41	57,47
46	240	452-46	64,87
50	253	452-50	76,25
55	266	452-55	87,20
60	280	452-60	91,94
65	300	452-65	120,10
70	330	452-70	142,45
75	330	452-75	152,97
80	360	452-80	203,51
85	360	452-85	254,35
90	390	452-90	327,30
95	390	452-95	349,85
100	420	452-100	419,67
105	420	452-105	482,64
110	450	452-110	529,60
115	450	452-115	594,49
120	480	452-120	731,16
125	480	452-125	972,39
130	520	452-130	1.057,54
135	520	452-135	1.090,87
140	520	452-140	1.305,18
145	580	452-145	1.717,67
150	580	452-150	1.808,17
155	580	452-155	1.963,24
160	650	452-160	2.080,48
165	650	452-165	2.210,09
170	650	452-170	2.218,02
175	650	452-175	2.379,26
180	650	452-180	2.553,74

478

Chiava a Forchetta Semplici a Percussione

DIN133

CrV



mm	L mm	Part N°	€
22	133	478-22	24,16
24	177	478-24	24,29
27	180	478-27	25,91
30	190	478-30	30,41
32	190	478-32	32,28
36	215	478-36	41,56
41	235	478-41	50,09
46	255	478-46	67,44
50	275	478-50	78,18
55	300	478-55	91,21
60	320	478-60	101,36
65	342	478-65	126,99
70	375	478-70	163,59
75	375	478-75	175,20
80	408	478-80	228,76
85	408	478-85	240,35
90	445	478-90	299,06
95	445	478-95	317,35
100	485	478-100	486,70
105	485	478-105	529,45
110	510	478-110	593,44
115	510	478-115	694,48
120	545	478-120	736,56
125	545	478-125	778,96

479

Chiavi a Forchetta Semplici

DIN894

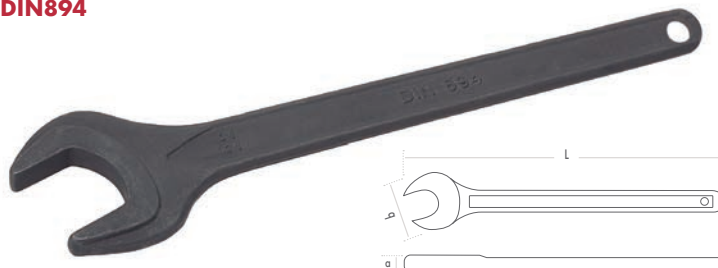

mm	L mm	a mm	b mm	Part N°	€
07	78	3,2	15	479-07	3,72
08	94	3,7	18	479-08	3,72
09	100	3,7	20	479-09	3,72
10	106	4,5	22	479-10	3,73
11	112	4,8	24	479-11	3,82
12	125	4,3	26	479-12	3,82
13	125	5,1	27	479-13	3,82
14	135	5,3	30	479-14	4,45
15	140	5,5	32	479-15	4,62
16	156	5,3	33	479-16	4,61
17	158	5,8	35	479-17	4,95
18	171	5,4	37	479-18	4,94
19	171	6,5	39	479-19	5,17
22	190	6,9	44	479-22	7,17
24	208	8,3	49	479-24	8,63
27	235	8,9	55	479-27	9,87
30	262	9,6	61	479-30	11,60
32	274	10,2	64	479-32	13,10
34	284	10,1	69	479-34	21,77
36	295	11,3	72	479-36	23,56
38	295	11,6	77	479-38	26,55
41	335	12,3	83	479-41	27,04
46	370	12,6	91	479-46	30,58
50	400	13,5	100	479-50	38,30
55	445	15,8	113	479-55	45,26
60	475	16,0	121	479-60	63,77
65	510	17,2	132	479-65	76,50
70	560	19,8	142	479-70	89,34
75	585	19,6	152	479-75	153,89
80	635	22,1	160	479-80	181,64
85	675	23,4	175	479-85	221,74
90	745	22,1	190	479-90	247,99
95	855	26,7	205	479-95	377,28
100	1000	26,1	205	479-100	384,55

Chiavi Fisse

Chiavi Poligonali Semplici Curvate Pesanti e Aste di Manovra

DOGHER
TOOLS

484

Chiavi Poligonali Semplici Curvate Pesanti

CrV



mm	Part N°	€
24	484-24	62,42
27	484-27	62,42
30	484-30	62,42
32	484-32	66,29
36	484-36	75,76
38	484-38	91,20
41	484-41	93,14
43	484-43	100,05
46	484-46	103,83
50	484-50	125,04
55	484-55	139,95
60	484-60	172,77
65	484-65	194,67
70	484-70	212,22
75	484-75	231,50
80	484-80	254,31
85	484-85	273,62
90	484-90	543,70
95	484-95	589,29
100	484-100	622,55
105	484-105	655,83
110	484-110	863,24
115	484-115	930,41

484

Aste di Manovra

CrV



L mm	Ø mm	g	Part N°	€
350	32	960	484-001	56,36
580	32	1.600	484-002	75,90
850	32	2.300	484-003	119,41

Chiavi isolate VDE secondo normativa DIN IEC 60900 testate a 10.000 VCA e certificate per 1.000 VCA.

4581

Chiavi a Forchetta Semplici Isolate



A mm	L mm	a mm	b mm	Part N°	€
6	89	7	22	4581-06	22,40
7	89	7	24	4581-07	22,50
8	99	7	25	4581-08	23,94
9	99	7	28	4581-09	24,03
10	108	8	29	4581-10	24,18
11	108	8	31	4581-11	24,61
12	129	8	33	4581-12	25,82
13	134	10	34	4581-13	25,82
14	144	10	37	4581-14	27,15
15	148	11	40	4581-15	27,14
16	158	11	42	4581-16	28,21
17	158	12	44	4581-17	28,76
18	173	12	44	4581-18	29,41
19	173	12	47	4581-19	30,53
21	194	12	50	4581-21	34,51
22	194	13	54	4581-22	38,83
24	224	13	56	4581-24	44,95
27	250	14	61	4581-27	48,02
30	287	14	66	4581-30	53,53
32	307	16	70	4581-32	54,83

4583

Chiavi Poligonali Curvate Isolate

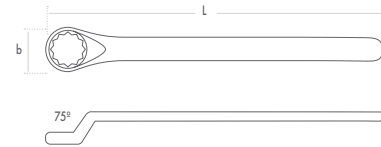

	L mm	b mm	Part N°	€
6	151	16	4583-06	32,27
7	153	17	4583-07	32,27
8	157	18	4583-08	34,00
9	157	20	4583-09	34,66
10	172	21	4583-10	34,56
11	173	23	4583-11	34,86
12	194	23	4583-12	34,86
13	194	26	4583-13	37,40
14	207	26	4583-14	38,45
15	207	27	4583-15	39,88
16	218	30	4583-16	40,44
17	220	31	4583-17	41,66
18	234	32	4583-18	42,40
19	234	34	4583-19	43,82
21	248	38	4583-21	46,12
22	250	38	4583-22	46,46
24	270	40	4583-24	46,46

4581

Busta in Nylon

14

Pcs

CrV



650 x 440 mm



8 • 9 • 10 • 11 • 12 • 13 • 14
17 • 19 • 22 • 24 • 27 • 30 • 32

Part N°	€
4581-002	475,01
451-002V *	23,47

* Busta in Nylon Vuota

Chiavi Regolabili

Isolate Serie VDE 1000V



495

Chiavi Regolabili a Rullino Centrale Isolate

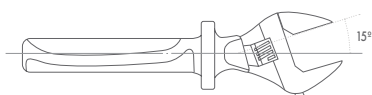

Impugnatura Bimateriale

L mm	L "	mm	Part N°	€
200	8	25	495-200	49,01
250	10	33	495-250	57,39

497

Chiavi Regolabili a Rullino Laterale Isolate

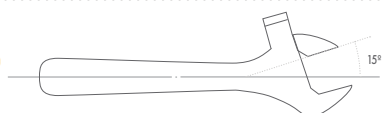

L mm	L "	mm	Part N°	€
200	8	28	497-200	174,73
250	10	33	497-250	195,37
300	12	38	497-300	212,85

• Chiave VDE isolata interamente per immersione.