

DOGHER
® TOOLS



**QUALIDADE INDUSTRIAL
MÁXIMO RENDIMENTO**

PREÇOS RECOMENDADOS
IVA NÃO INCLUIDO

**PROMOÇÃO
2025**

BANCADA METÁLICA DE TRABALHO 2 GAVETAS E PAINEL VERTICAL PORTAFERRAMENTAS



1500
730

- Painel Vertical Portaferramentas.
- 2 Gavetas de Alta Capacidade

Carga Total: **900 kg**
Bancada: **1500 x 640 x 1550 mm**
Painel Portaferramentas: **1500 x 730 mm**

10 x 10 mm
38 x 38 mm

Ref 027-004
~~1.327,47 €~~ **761,34 €**

BANCADA METÁLICA DE TRABALHO 3 GAVETAS



- 3 Gavetas de Alta Capacidade

Carga Total: **500 kg**
Bancada: **2000 x 640 x 865 mm**

Ref 027-001
~~1.280,58 €~~ **753,28 €**

TORNOS DE BANCADA GUÍA REDONDA



L mm	A mm	Kg	Ref		
▶ 100	105	13	925-100	339,42 €	199,68 €
125	130	22	925-125	467,36 €	274,91 €
150	165	32	925-150	667,33 €	392,54 €

• Base giratória, consulte a página. 493

TORNOS DE BANCADA GUÍA QUADRADA



L mm	A mm	Kg	Ref		
▶ 100	105	7,5	926-100	226,98 €	133,51 €
125	155	14	926-125	252,93 €	148,79 €
150	165	19	926-150	365,18 €	214,82 €
175	205	26	926-175	578,33 €	340,19 €

• Base giratória, consulte a página. 493

MORDAZA DE FIBRA PARA TORNILLOS DE BANCO GUÍA REDONDA

NOVIDADE



L mm	Ref		
▶ 100	925F-100	21,00 €	12,35 €
125	925F-125	24,22 €	14,25 €
150	925F-150	26,36 €	15,50 €

MORDAZA DE FIBRA PARA TORNILLOS DE BANCO GUÍA CUADRADA

NOVIDADE



L mm	Ref		
▶ 100	926F-100	21,00 €	12,35 €
125	926F-125	24,22 €	14,25 €
150	926F-150	26,36 €	15,50 €
175	926F-175	28,28 €	16,63 €

BOMBA DE GRAXA COM MANGUEIRA FLEXÍVEL

8.000
PSI



1/8 BSP

Granel cc	Cartucho gr	L bomba	Ø bomba	L mangueira	Ø mangueira	Ref		
500	400	350	57,5	300	8,5	915-030	38,18 €	22,46 €



- Válvula de liberação de ar
- Carga a Granel

PISTOLAS DE SOPRAGEM PROGRESSIVAS



Ø mm
8

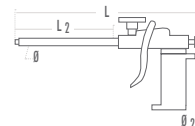

L mm	L2 mm	Ø mm	Ø2 mm	Ref		
▶ 210	100	8	1/4" G (BSP)	914-010	19,32 €	11,37 €

- Pressão máxima: 12 Bar · 175 PSI · 1,2 Mpa
- Bico com reforço de metal.
- Corpo de POM (Acetal) de alto desempenho.

L mm	L2 mm	Ø mm	Ø2 mm	Ref		
▶ 306	202	8	1/4" G (BSP)	914-015	22,66 €	13,32 €

- Pressão máxima: 12 Bar · 175 PSI · 1,2 Mpa
- Bico com reforço de metal.
- Corpo de POM (Acetal) de alto desempenho.



MÁXIMAS PRESTAÇÕES

- 3 Módulos desmontáveis
- 1 Caixa de ferramentas
- 2 Gavetas de alta capacidade
- 1 Arca reclinável

**SOLUÇÕES
3 EM 1**

Ref 051-002

~~319,95 €~~ **188,21 €**

490 x 300 x 720 mm

AMARRAÇÕES INTERMÓDULO METÁLICAS

Mais robustas, evita oscilações

FECHOS DE SEGURANÇA

Duplo fecho metálico de segurança

ALOJAMENTO PARA FECHO COM CADEADO



TROLLEY DE 3 MÓDULOS

+47 FERRAMENTAS



300 mm
720 mm
490 mm

27
Pcs

1/2"



(531-080)

8 • 9 • 10 • 11 • 12 • 13 • 14 • 15 • 16 • 17
18 • 19 • 20 • 21 • 22 • 23 • 24 • 27 • 30 • 32

250 mm
125 mm

3/8" • 1/2" (524-021)

16 • 21

Ref 051-500

~~874,77 €~~ **501,71 €**

10
Pcs



(450-081)



6x7 • 8x9 • 10x11 • 12x13 • 14x15
16x17 • 18x19 • 20x22 • 21x23 • 24x26

10
Pcs

DE
1000V



(330-084)

TESTED

4 • 5,5 • 6,5 PH1 • PH2

4 • 5,5 • 6,5 PH1 • PH2

TROLLEY METÁLICA

COMPACTA

- 1 Caixa de ferramentas com bandeja interior portátil
- 2 Gavetas
- 1 Arca reclinável de alta capacidade
- Alça traseira telescópica desmontável



265 mm
550 mm
410 mm

FECHOS DE SEGURANÇA
Duplo fecho metálico de segurança

Ref 051-008

~~192,49 €~~ **99,07 €**

TROLLEY METÁLICA

COMPACTA

- 1 Caixa de ferramentas com bandeja interior portátil
- 4 Gavetas (2 de alta capacidade)
- Alça traseira telescópica desmontável



265 mm
550 mm
410 mm

FECHOS DE SEGURANÇA
Duplo fecho metálico de segurança

Ref 051-009

~~202,79 €~~ **119,28 €**



TROLLEY
3 MÓDULOS

- 1 Arca reclinável
- 1 Caixa de ferramentas
- 3 Gavetas de alta capacidade
- Rodas de plástico de alta resistência



Ref 051-004
~~181,85 €~~ **106,97 €** 505 x 330 x 835 mm

ORGANIZADOR
COM ALÇA MÓVEL ALTA CAPACIDADE

- Caixas Organizadoras Extraíveis



Ref 052-010
~~21,53 €~~ **9,50 €**
340 x 250 x 60 mm

CAIXA DE FERRAMENTAS
1 BANDEJA + 3 ORGANIZADORES

- Duplo fecho metálico de segurança
- Bandeja interior portátil



Ref 050-010
~~47,20 €~~ **27,07 €**
490 x 262 x 250 mm

CAIXA DE FERRAMENTAS
MÓVEIS

3 Organizadores para Acessórios



Ref 051-006
~~148,80 €~~ **87,53 €**
620 x 370 x 420 mm



ARCA METÁLICA GALVANIZADA
COM FECHO METÁLICO DE SEGURANÇA

L mm	Carga Máxima	Ref	159,90 €	94,06 €
555 x 230 x 210	40 kg	028-002	270,75 €	159,26 €
759 x 327 x 250	50 kg	028-003*	334,77 €	196,91 €
1.144 x 367 x 380	50 kg	028-004*	582,95 €	342,91 €
1.429 x 502 x 476	60 kg	028-005*		

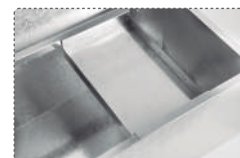

* Bandeja Incluída





CAIXA METÁLICA DE FERRAMENTAS +50 FERRAMENTAS QUALIDADE INDUSTRIAL

- Caixa metálica Ref:026-001 incluída
- 5 bandejas de alta qualidade
- Carga Máxima até 30 Kg.



COMPOSIÇÃO PROFISSIONAL

Inclui caixa de ferramentas + 50 Ferramentas



495 x 200 x 230 mm

Ref 026-500
~~748,56 €~~ **432,12 €**



CAIXA DE FERRAMENTAS 5 BANDEJAS

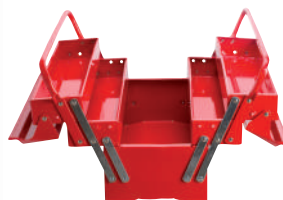

Ref 026-001
~~97,36 €~~ **57,25 €**

495 x 200 x 230 mm

CAIXA DE FERRAMENTAS 3 BANDEJAS



Ref 026-002
~~76,90 €~~ **45,24 €**

495 x 200 x 180 mm

CAIXA DE FERRAMENTAS 5 BANDEJAS SERIE LONGA



Ref 026-005
~~108,78 €~~ **63,99 €**

550 x 200 x 208 mm

CAIXA DE FERRAMENTAS METÁLICA PROFISSIONAL



- 1 Compartimento
- 2 Gavetas
- Duplo Fecho Metálico de Segurança
- 30 kg Carga Máxima Total permitida

Ref 026-003
~~131,75 €~~ **58,12 €**

510 x 218 x 250 mm

1 CAIXA DE FERRAMENTAS 1 BANDEJA + 6 GAVETAS

- Bandeja superior
- Alças laterais
- Fecho de segurança com chave

Ref 028-001
~~520,77 €~~ **306,34 €**

668 x 316 x 386 mm



- 5 kg Carga Máxima por Gaveta



WATERPROOF TROLLEY

- Resistente à água e totalmente hermética (IP 67).
- Empilhável.
- À prova da corrosão, areia e pó.
- Resistente ao choque. Inquebrável e robusta.
- Resistente a temperaturas entre -40 ° C / + 90 ° C.
- Alça ergonómica com o punho revestido de borracha.
- Fechos sem atolamento com mecanismo de abertura fácil.
- Dobradiças de metal à prova de corrosão feitas com as mesmas características da tampa.
- Válvula automática de libertação de pressão.
- Anel de vedação.
- Dimensões ext.: 568x467x274mm / Dimensões int.: 546x392x233 mm
- Profundidade da tampa: 54 mm / Profundidade da base: 179 mm



Ref 051-010



Ref 051-010

~~742,26 €~~ **436,62 €**

568 x 467 x 274 mm

TROLLEY INDUSTRIAL

Ref 051-510
~~2.564,60 €~~ **1.470,88 €**

• Veja Composição na pág. 41 do Catalogo Geral.



139
Pcs



TROLLEY ELETRICISTA

139
Pcs

Ref 051-511
~~2.812,85 €~~ **1.613,26 €**

• Veja Composição na pág. 42 do Catalogo Geral.

TROLLEY ELETRICISTA VDE

Ref 051-512
~~2.558,80 €~~ **1.505,19 €**

• Veja Composição na pág. 43 do Catalogo Geral.

67
Pcs

5331-001



ANTI-CORROSÃO



RESISTENTE A ALTAS E BAIXAS TEMPERATURAS



À PROVA DE CHOQUE



BAÚ COM RODAS DE POLIPROPILENO DE ALTA DENSIDADE



Ref 028-020
~~321,73 €~~ **188,31 €**

780 x 410 x 330 mm



- Baú de alta resistência
- Peso leve e alta capacidade de carga
- Adequado para uso externo
- Alça frontal
- Rodas de alta resistência
- Opção de fechamento por meio de cadeado
- Empilhável
- Ideal para construção, manutenção e transporte



ANTI-CORROÇÃO



RESISTENTE A ALTAS E
BAIXAS TEMPERATURAS



À PROVA DE
CHOQUE

D-BOX
by DOGHER TOOLS

MALA COMPACTA PROFISSIONAL DE GRANDE CAPACIDADE



- Polipropileno moldado por injeção
- Extremamente leve
- Alça ergonômica para fácil transporte
- Rodas de alta resistência
- Fechaduras laterais com chave
- Faixa superior para documentos
- Inclui 2 organizadores na base
- Área inferior com divisórias removíveis

Ref 051-015

~~449,45 €~~ **263,06 €**

430 x 320 x 190 mm



MALA COMPACTA PROFISSIONAL

+69 FERRAMENTAS QUALIDADE INDUSTRIAL



69
Pcs



Ref 051-515

~~1.019,03 €~~ **596,43 €**



ANTI-CORROÇÃO



RESISTENTE A ALTAS E
BAIXAS TEMPERATURAS



À PROVA DE
CHOQUE

TEKBOX
by DOGHER TOOLS

MALA COMPACTA PROFISSIONAL DE GRANDE CAPACIDADE



- Polipropileno moldado por injeção
- Alça ergonômica para fácil transporte
- Rodas de alta resistência
- Fechadura dupla com duas chaves
- Etiqueta externa de identificação
- Painéis porta-ferramentas removíveis
- Compartimento inferior com divisórias ajustáveis e removíveis
- Dobradiças metálicas de alta resistência

Ref 051-016

~~567,79 €~~ **332,32 €**

465 x 352 x 255 mm



MALA COMPACTA PROFISSIONAL

+94 FERRAMENTAS QUALIDADE INDUSTRIAL



94
Pcs



Ref 051-516

~~1.543,72 €~~ **903,53 €**

Mala de Alumínio + 85 Ferramentas Qualidade Industrial



Ref 051-020
~~111,16 €~~ **65,37 €**

Mala de alumínio leve e muito resistente com proteções de metal nos cantos. Fecho duplo com chave e alça bimatérial. Borrachas de apoio nos 2 lados para colocá-la em qualquer superfície sem danificar a mala. O interior é composto por uma bandeja móvel e uma bandeja fixa na parte superior, adequadas para a colocação de ferramentas. A bandeja móvel, unida à mala por 3 dobradiças resistentes, pode ser ajustada em 2 posições usando uma correia fixada à tampa superior.



**MALA LEVE DE ALUMÍNIO
+85 FERRAMENTAS QUALIDADE INDUSTRIAL**

- | | |
|--|--|
| | 8 • 10 • 12 • 13 • 14 • 15 • 16 • 17 • 18 • 19 • 21 • 22 • 24 • 27 • 30 • 32 |
| | 544-001 1/2" |
| | 491-250 |
| | 605-009 |
| | 212-180 |
| | 208-160 |
| | 205-180 |
| | 296-006 |
| | 269-240 |
| | 789-001 |
| | 785-001 |
| | 778-05 |
| | 470-001 |
| | 438-001 |
| | Fenda Plana 8 • 10 • 11 • 12 • 13 • 14 • 17 • 19 |



85
Pcs



EXTERNAS 465 x 375 x 165 mm
INTERNAS 445 x 337 x 96 mm

Ref 051-520
~~839,28 €~~ **493,71 €**

**MOCHILA PORTA-FERRAMENTAS
COM RODAS**



- Máximas Prestações:
- Compartimentos específicos para todas as ferramentas
- Grande capacidade de armazenagem
- zíper de abertura para acesso rápido no interior
- Alça Reforçada Ergonômica
- Alça telescópica
- Fitas Reguláveis de Rápida Adaptação

Ref 076-014
~~166,75 €~~ **98,09 €**



360 x 275 x 500 / 1050 mm

**MOCHILA PROFISSIONAL
+ 1 ORGANIZADOR + 32 FERRAMENTAS**



Ref 076-520

~~545,89 €~~ **321,10 €**

• Veja Composição na pág. 60

**MOCHILA ELETRICISTA
+ 1 ORGANIZADOR + 29 FERRAMENTAS**



Ref 076-521

~~520,78 €~~ **306,34 €**

• Veja Composição na pág. 60

MOCHILA PROFISSIONAL VAZIA

- Compartimentos específicos para todas as ferramentas
- Grande capacidade de armazenagem
- Zíper de abertura para acesso rápido no interior
- Contém bolso específico para o organizador Ref. 052-014
- Alça Reforçada Ergonômica
- Fitas Reguláveis de Rápida Adaptação



- 410 x 295 x 240 mm
- 20 kg Carga máxima

Ref 076-004

~~79,70 €~~ **46,88 €**

* Ferramenta não incluída

MOCHILA PROFISSIONAL + 1 ORGANIZADOR + 32 FERRAMENTAS



410 x 295 x 240 mm

Ref 076-500

~~458,84 €~~ **269,91 €**

· Veja Composição na pág. 59

Ref 076-501

~~433,73 €~~ **255,15 €**

· Veja Composição na pág. 59

CAIXA PARA FERRAMENTAS ABERTA UNIVERSAL

- Barra rígida reforçada para o transporte
- Grande capacidade de armazenagem
- Revestimento interior impermeável
- Acomodações específicas para as ferramentas
- Alça e bandoleira para o cómodo transporte



410 x 215 x 335 mm

Ref 076-002

~~76,71 €~~ **45,12 €**

* Ferramenta não incluída

SACO PARA FERRAMENTAS UNIVERSAL

- Abertura rígida para o fácil acesso
- Grande capacidade de armazenagem
- Revestimento interior impermeável



520 x 250 x 290 mm

Ref 076-012

~~78,95 €~~ **46,44 €**

* Ferramenta não incluída

COLDRE PORTA-FERRAMENTAS COM ALÇA

- Alça reforçada ergonômica
- 18 Compartimentos versáteis
- Fitas reguláveis de rápida adaptação



350 x 85 x 195 mm

Ref 076-003

~~49,81 €~~ **29,29 €**

* Ferramenta não incluída

SACO PARA FERRAMENTAS

- Grande capacidade de armazenagem, imprescindível para o profissional
- Bandoleira para o cómodo transporte
- Acomodações específicas para as ferramentas no interior e no exterior



290 x 185 x 220 mm

Ref 076-006

~~55,56 €~~ **32,68 €**

* Ferramenta não incluída

**GAMBIARRAS LED
RECARREGÁVEIS**

**GAMBIARRA RECARREGÁVEL
700 LUMENS COB LED**

VEGA



Ref 1000-001

~~91,50 €~~ **53,56 €**

268 x 61 x 42 mm

**GAMBIARRA RECARREGÁVEL
400 LUMENS COB LED**

ALTAIR



Ref 1000-002

~~90,35 €~~ **52,88 €**

268 x 61 x 42 mm

**GAMBIARRA RECARREGÁVEL
450 LUMENS COB LED**

POLUX



Ref 1000-003

~~89,10 €~~ **52,15 €**

199 x 51 x 36 mm

**GAMBIARRA UV RECARREGÁVEL
395nm WAVELENGTH COB LED**

ADHARA



Ref 1000-004

~~92,25 €~~ **54,00 €**

199 x 51 x 36 mm

**GAMBIARRA RECARREGÁVEL
300 LUMENS COB LED**

COMPACT



Ref 1000-009

~~96,21 €~~ **56,31 €**

127 x 69 x 33 mm

**GAMBIARRA RECARREGÁVEL
150 LUMENS COB LED**

STYLO



Ref 1000-015

~~78,36 €~~ **45,87 €**

167 x 25 x 33 mm

**GAMBIARRA RECARREGÁVEL
1000 LUMENS COB LED**

RIGEL



Ref 1000-020

~~96,36 €~~ **56,40 €**

397 x 66,5 x 46 mm

**GAMBIARRA RECARREGÁVEL
280 LUMENS COB LED**

SHAULA



Ref 1000-021

~~73,10 €~~ **42,78 €**

307 x 30 x 17 mm

**GAMBIARRAS LED
RECARREGÁVEIS**

**GAMBIARRA RECARREGÁVEL
1000 LUMENS COB LED**



NOVIDADE

Ref 1000-025
~~105,36 €~~ **61,97 €**

348 x 46 x 60 mm



**GAMBIARRA RECARREGÁVEL
1000 LUMENS LED**



NOVIDADE

Ref 1000-040
~~116,24 €~~ **68,38 €**

251 x 46 x 44 mm

**GAMBIARRA RECARREGÁVEL
2000 LUMENS COB LED**



NOVIDADE

Ref 1000-050
~~126,54 €~~ **74,44 €**

113 x 104 x 62 mm

**BASE DE CARREGAMENTO
SEM FIO 15W**

NOVIDADE

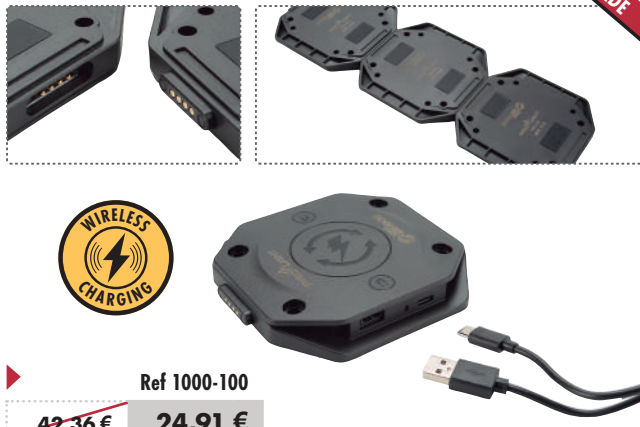

Ref 1000-100
~~42,36 €~~ **24,91 €**

116 x 112 x 17 mm

**GAMBIARRA FRONTAL
400 LUMENS COB LED**



Ref 1000-030
~~56,36 €~~ **32,99 €**

47,5 x 78,5 x 42 mm

- Faixa ergonômica ajustável e antiderrapante de alta qualidade.

- 4 ângulos de Posicionamento.

- Sensor de movimento ON/OFF sem contato.
- Tomada USB-C

ALICATE EXTRA LONGO
PONTAS SEMI-REDONDAS RETAS

NOVIDADE

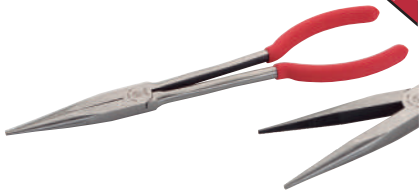

▶ 280 mm Ref 2200-281
~~26,12 €~~ 15,37 €

ALICATE EXTRA LONGO
PONTAS SEMI-REDONDAS 45°

NOVIDADE



▶ 280 mm Ref 2200-282
~~26,12 €~~ 15,37 €

ALICATE EXTRA LONGO
PONTAS SEMI-REDONDAS 90°

NOVIDADE



▶ 280 mm Ref 2200-283
~~26,12 €~~ 15,37 €

ALICATES PARA FREIOS
MULTI-CIRCLIP®



6 EM 1

- Função CIRCLIP® interior / exterior com bocas retas e curvas
- Inclui 3 pares de pontas de reposição:
1 par de pontas retas + 2 pares de pontas curvas



▶ 200 mm Ref 220-001
~~47,73 €~~ 28,07 €

ALICATES PARA FREIOS
CIRCLIP® PRO

- Pontas reforçadas
- Maior durabilidade e resistência

ALICATE CIRCLIP® PRO
RETO EXTERIOR



L mm	∅ Min mm.	∅ Max mm.	Ref	Price	Price
▶ 140	3	10	220X-140	27,90 €	16,21 €
140	10	25	220X-155	24,92 €	14,49 €
180	19	60	220X-180	29,10 €	16,90 €
240	40	100	220X-220	33,64 €	19,54 €
330	85	140	220X-300	55,57 €	32,28 € ▶

ALICATE CIRCLIP® PRO
CURVO EXTERIOR



L mm	∅ Min mm.	∅ Max mm.	Ref	Price	Price
▶ 130	3	10	221X-140	27,90 €	16,21 €
130	10	25	221X-155	25,40 €	14,75 €
170	19	60	221X-180	28,69 €	16,66 €
220	40	100	221X-220	34,26 €	19,91 €
315	85	140	221X-300	55,57 €	32,28 € ▶

ALICATE CIRCLIP® PRO
RETO INTERIOR



L mm	∅ Min mm.	∅ Max mm.	Ref	Price	Price
▶ 140	8	13	222X-140	27,90 €	16,21 €
140	12	25	222X-155	25,40 €	14,75 €
180	19	60	222X-180	29,10 €	16,90 €
230	40	100	222X-220	33,64 €	19,54 €
320	85	140	222X-300	55,57 €	32,28 € ▶

ALICATE CIRCLIP® PRO
CURVO INTERIOR



L mm	∅ Min mm.	∅ Max mm.	Ref	Price	Price
▶ 125	8	13	223X-140	27,90 €	16,21 €
125	12	25	223X-155	25,40 €	14,75 €
170	19	60	223X-180	29,10 €	16,90 €
220	40	100	223X-220	34,57 €	20,07 €
300	85	140	223X-300	55,57 €	32,28 € ▶

ESTOJO COM ZIPER
CIRCLIP® PRO



L mm	∅ Min mm.	∅ Max mm.	Ref	Price	Price
▶ 155	12	25	220X-004	110,37 €	64,10 €
180	19	60	220X-002	125,24 €	72,74 € ▶



290 x 215 mm

CHAVE PARA TUBO MOD. AMERICANO ALUMÍNIO PROFISSIONAL

- Dureza nas bocas 60 HRc
- Abertura 38% maior do que na Stillson forjada
- Corpo de alumínio, 40% mais ligeiro
- Corpo monoblock, maior robustez



CrV



L"	L mm	Ø max.	Ref	Price	Price
▶ 10	250	Ø49	655-250	49,89 €	28,62 €
14	350	Ø60	655-350	66,48 €	38,13 €
18	450	Ø76	655-450	95,05 €	54,51 €
24	600	Ø90	655-600	140,89 €	80,81 €
36	900	Ø140	655-900	280,81 €	161,04 €
48	1210	Ø168	655-1210	453,85 €	260,29 € ▶

CHAVE PARA TUBO MOD. STILLSON FORJADA PROFISSIONAL

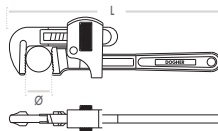

60HRc

CrV



L"	L mm	Ø max.	Ref	Price	Price
▶ 8	200	Ø25	650-200	27,21 €	15,60 €
10	250	Ø35	650-250	36,08 €	20,69 €
12	300	Ø44	650-300	41,52 €	23,81 €
14	350	Ø50	650-350	45,88 €	26,31 €
18	450	Ø60	650-450	62,02 €	35,56 €
24	600	Ø76	650-600	100,92 €	57,87 €
36	900	Ø102	650-900	207,54 €	119,03 € ▶

CHAVE DE CORRENTE REVERSÍVEL

CrV



L"	L mm	Ø mm	Ref	Price	Price
▶ 12	300	90	662-001	53,42 €	31,43 € ▶

CURVADORA MULTIUSO DE TUBO



▶ Ref 662-020
~~42,36 €~~ 24,79 €

· Para Tubo de 6-8-10 mm



CORTA-TUBOS PARA PVC COM RETROCESSO AUTOMÁTICO

PPRC



Position 1 **Ø27 mm**
Position 2 **Ø45 mm**



Soft TOUCH



▶ 0-45 mm Ref 665-45
~~73,48 €~~ 43,22 €

- Corta polietileno, PPR, Multicamadas...
- Pino para seleccionar a capacidade de corte (27 a 45 mm)
- Lâmina de Aço Forjado e Temperado

CORTA-TUBOS REGULÁVEL PARA METAL

Cu
Al
Inox



▶ 3-32 mm Ref 675-03-32
~~26,33 €~~ 15,10 €

Inclui Rebarbador

CHAVES DE CABINE DE ÁGUA, GÁS E ELECTRICIDADE

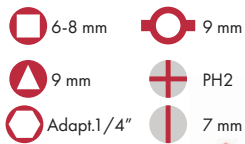

Ref 470-001

~~23,37 €~~ 13,74 €

CHAVES DE CABINE DE AQUECIMENTO E AR CONDICIONADO

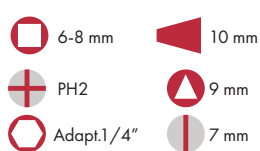

Ref 470-002

~~23,79 €~~ 13,99 €

CHAVES DE CABINE UNIVERSAL

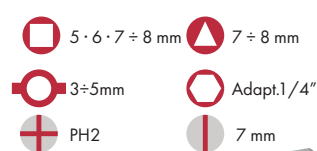

Ref 470-004

~~25,31 €~~ 14,88 €

ALICATE

AJUSTE RÁPIDO COM BOTÃO

- Boca mais comprida e estreita.
- Maior acessibilidade em espaços reduzidos.
- Corpo forjado em aço cromo-vanádio
- Punho antiderrapante em PVC
- Revestimento azulado anticorrosivo
- Bocas temperadas em óleo. Maior resistência e durabilidade
- Botão com 4 dentes de bloqueio
- 35% mais de abertura

CrV



L mm	Ø max. mm	Ref	Price	Price
150	26	269-150	40,46 €	23,68 €
180	38	269-180	43,25 €	24,81 €
240	50	269-240	46,14 €	26,46 €
300	70	269-300	57,29 €	32,87 €
400	90	269-400	100,93 €	57,88 €

ALICATE STD

AJUSTÁVEL COM BOTÃO

CrV



L mm	Ø max. mm	Ref	Price	Price
150	26	2690-150	26,36 €	15,43 €
180	38	2690-180	30,25 €	17,71 €
250	50	2690-250	33,14 €	19,01 €
300	70	2690-300	46,75 €	26,81 €

Alicate ajustável STD

DE BOTÃO COM FUNÇÃO CHAVE

L mm	Ø mm	Ref	Price	Price
250	48	269-010	64,85 €	38,15 €

CrV



NOVIDADE

ALICATE

AJUSTÁVEL

CrV



L mm	Ø mm	Ref	Price	Price
250	37	268-250	23,82 €	14,01 €

ALICATE AJUSTÁVEL

COM PUNHO ANTI-DERRAPANTE

CrV



L mm	Ø mm	Ref	Price	Price
250	48	267-250	31,97 €	18,79 €

FERRAMENTA PARA TENSÃO

DE ABRAÇADEIRA DE FIVELA

CrV

L mm	Max mm	Ref	Price	Price
190	12 x 2,3	268-010	58,63 €	34,31 €



ESTOJO COM ZIPER

ALICATES

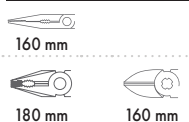

Ref 210-002

~~72,81 €~~ 42,82 €

ALICATE DE PRESSÃO

AUTO-AJUSTÁVEL



- Ajuste de pressão através do mecanismo interno.
- Cabo serilhado anti-derrapante.
- Bocas atemperadas para maior durabilidade.
- Alicate de pressão AUTOMÁTICO patentado.



CrMo

L mm	L"	Ref
150	6	275-005
250	10	275-010

46,20 €	27,04 €
50,38 €	29,63 €

ALICATE DE PRESSÃO
BOCA CURVA SEM CORTE

- Boca Curva
- Bocas de grande abertura indicadas para as formas arredondadas. Para trabalhar em oficina, canalização, etc.
- Bocas curvas e finas de grande capacidade: permitem um agarramento firme nas formas arredondadas.

L mm	L"	Ref
175	7	275-175
250	10	275-250

27,50 €	16,18 €
31,24 €	18,37 €

ALICATE DE PRESSÃO
BOCA CURVA COM CORTE

L mm	L"	Ref
175	7	276-175
250	10	276-250

26,63 €	15,66 €
29,03 €	17,07 €

ALICATE DE PRESSÃO
BOCA CURVA GRANDE CAPACIDADE

L mm	Ø mm	P mm	Ref
250	85	73	275F-011

72,51 €	42,66 €
--------------------	---------

ALICATE
DE PRESSÃO

CrV

L mm	L"	B mm	A mm	Ref
200	8	70	30	275-050

75,14 €	43,99 €
--------------------	---------

TESOURA PARA CORTE
EM ÂNGULO

49,08 €	28,87 €
--------------------	---------

Ref 285-45-135

SK5

45°
135°

- Aço temperado com punho antiderrapante.
- Para borrachas, perfis e calhas de largura de 40 mm máx. e comprimento de 25 mm máx.
- Para cortes retos e ângulos de 45° a 135°



TESOURA

CUT-PRO

- Microdentado anti-derrapante.
- Punho bi-material.

Inox



CUT PRO

TESOURA MULTIFUNÇÃO



Inox



▶ 206 mm Ref 296-011
~~25,23 €~~ 14,76 €

TESOURA DE ELETRICISTA ANGULADA MULTIFUNÇÕES



Inox



NOVIDADE



▶ 204 mm Ref 296-012
~~58,05 €~~ 34,15 €

TESOURA CUT-PRO PARA ELETRICISTA



▶ 170 mm Ref 296-010
~~47,67 €~~ 28,04 €

- Alojamento para o fio 0,3mm²/0,5mm²/1 mm²/1,5mm²/2,5 mm²/4 mm²/6mm².
- Capacidade máx. de corte até 1x100 mm²
- Corpo inteiro em aço inoxidável.
- Prensa para terminais 2,5 a 6,0 mm²

TESOURA CUT-PRO XXL PARA ELETRICISTA



Inox



- Capacidade máx. de corte até 1x50 mm²
- Corpo inteiro em Aço Inox
- Prensa para terminais e Alojamento especial para o fio. 1,5mm² / 2,5mm².

▶ 160 mm Ref 296-009
~~35,78 €~~ 21,04 €

TESOURA CUT-PRO PARA ELETRICISTA



Inox



▶ 150 mm Ref 296-008
~~23,16 €~~ 13,62 €

TESOURA PARA ELETRICISTA COM EMPUNHADURA XXL



Inox



- Folha de serra
- Empunhadura bimatéria
- Corte máximo 1 x 50 mm²

▶ 150 mm Ref 296-004
~~27,38 €~~ 15,90 €

TESOURA PARA ELETRICISTA

- Folha de serra
- Empunhadura bimatéria

Inox



▶ Ref Tesoura+Capa 296-007
~~26,81 €~~ 15,40 €

▶ 145 mm Ref 296-006
~~22,69 €~~ 13,34 €

DESCARNA MANGUEIRAS

DESCARNA FIOS



• Ø 4 - 28 mm 5/32" - 1 1/8" • Ø 0,5 - 6 mm² 20 - 10 AWG



▶ Ref 296-132
~~38,22 €~~ 22,47 €

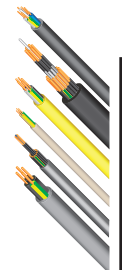

DESCARNA FIOS AUTOMÁTICO AJUSTÁVEL



• Ø 0,2-6 mm² 24-10 AWG



▶ Ref 296-152
~~48,45 €~~ 28,50 €

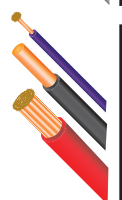

JOGO DE ALICATE DE CRAVAR

218 mm 8,5" QUICK CHANGE



- Aço tratado de alta resistência ao desgaste.
- Mecanismo de mudança rápida das bocas.
- Sistema de bloqueio/desbloqueio.
- Punho bimaterial ergonómico.

Ref 296-064
~~182,37 €~~ 106,74 €

ALICATE DE CRAVAR COM ROQUETE PARA TERMINAIS DE CONEXÃO SOLAR



225 mm 9" MC4



PATENTED

- 2,5 - 4 - 6 mm²
- AWG 14 - 12 - 10

Ref 296-066
~~130,37 €~~ 76,31 €

ALICATE DE CRAVAR PONTAS OCAS ISOLADAS E ACESSO LATERAL



0,25-16 mm²

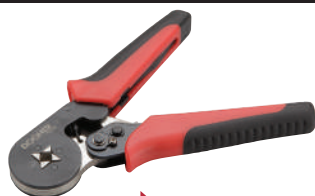

- Para pontas: 0,25 ~ 16 mm²

Ref 296-061
~~96,67 €~~ 56,87 €

ALICATE DE CRAVAR TERMINAIS ISOLADO COM ROQUETE



- Faixa de terminais isolados 1,5 • 2,5 • 6 mm²

220 mm Ref 296-060
~~37,85 €~~ 22,26 €

ALICATE DE CRAVAR FICHAS COM ROQUETE



203 mm



- Para cravar fichas **RJ45** e **RJ11** de 6 e 8 pólos.
- Lâmina para fios de 6 e 12 mm.

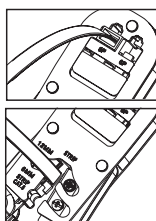

- Aperte o punho para ativar a ação de prensagem.



- Descarnar fio plano.

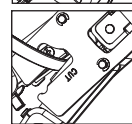

- Descarnar fio redondo CAT.5.

- Cortar fios de rede.

Ref 296-062
~~84,60 €~~ 49,76 €

CRIMPADOR DE REDE MULTIFUNÇÕES



407 g 140 mm

NOVIDADE

RJ11 6P2C • RJ12 6P4C/6P6C
RJ45 8P4C/8P6C/8P8C
CAT 7 ↔ CAT 5 • CAT 6

Ref 296-077
~~58,26 €~~ 34,26 €

ALICATE DE CRAVAR DE IMPACTO TIPO KRONE



NOVIDADE

Ref 296-078
~~19,94 €~~ 11,74 €

CORTA-CABOS

COM ROQUETE

> 52 mm <

280 mm

- Corta-cabos com roquete forjado em aço especial para ferramentas.
- Corte de cabos de cobre e alumínio, simples e múltiplos.
- Especial para trabalhos em situações de difícil acesso.
- Bordas de corte temperadas.
- Trava de segurança.
- Alavanca de liberação da pressão.
- Punho bi-material com área de suporte.

Cu 300 mm²
Al 400 mm²

L mm Ref
▶ 280 295-021



~~387,11 €~~ 227,72 € ▶

DESCARNA MANGUEIRAS

PROFISSIONAL



- Lâmina SK2 retificada
- Punho antiderrapante
- Roleta para o ajuste da profundidade de corte

L mm Ø mm Ref
▶ 190 8~28 296-031

190 mm

~~24,39 €~~ 14,35 € ▶



NAVAJA

PARA ELETRICISTA



195 mm

Inox

L mm Ref
▶ 195 296-021



~~19,54 €~~ 11,50 € ▶

ALICATE

CORTA-ARAMES



CrV



L mm Ø mm² A Max. Ref
▶ 530 250 23,6 295-014

~~231,94 €~~ 135,75 € ▶

- Corta cabos simples e múltiplos de cobre e alumínio sem blindagem.
- Arestas de corte endurecidas.
- Punho tubular de aço.

A max.



ALICATE

ISOLADO VDE 1000V



L mm Ø mm² Ref
▶ 170 15 259-017

~~46,68 €~~ 27,46 € ▶

NOVIDADE

ARCO DE SERRA

ISOLADO VDE 1000V



L mm Ref
▶ 483 8040-001

~~83,36 €~~ 49,03 €

DIN EN/IEC 60900

483 mm

300 mm



NOVIDADE

MARTELO DE NYLON

ISOLADO VDE 1000V



L mm Ø mm Ref
▶ 300 30 7410-30

~~201,36 €~~ 118,44 € ▶

NOVIDADE

CORTA-CABOS COM ROQUETE

ISOLADO VDE 1000V



L mm Ref
▶ 280 2095-021

~~456,36 €~~ 268,45 € ▶

NOVIDADE



CHAVES DE PARAFUSOS ISOLADAS VDE 1000V

- Punho Bimaterial Isolado
- Vareta Circular Isolada
- Certificado VDE de Garantia
- 56 HRc



6 CHAVES DE PARAFUSOS ISOLADAS 1000V

- Retas 3 · 4 · 5,5 · 6,5
- PH1 · PH2

Ref 360-005

~~66,70 €~~ **38,26 €**



7 CHAVES DE PARAFUSOS ISOLADAS 1000V

- Retas 3 · 4 · 5,5 · 6,5
- PH0 · PH1 · PH2

Ref 360-001

~~74,22 €~~ **43,66 €**



ESTOJO COM ZIPER ALICATES ISOLADOS



160 mm

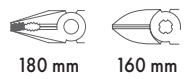

180 mm

160 mm



Ref 250-002

~~123,71 €~~ **70,96 €**

JOGO DE CHAVES COM VARETAS INTERMUTÁVEIS 14 PEÇAS

- 1 Punho
- 1 Tampa
- 1 Chave Tipo Tester
- 11 Varetas intermutáveis

2,5 · 3,5 · 4,0 · 5,5 · 6,5

PH0 · PH1 · PH2

T10 · T15 · T20



Ref 360-012

~~77,83 €~~ **45,78 €**

MALA VDE 19 PEÇAS



390 mm
675 mm
705 mm

Ref 080-001

~~267,67 €~~ **157,46 €**



Alicate Isolado Pontas Semirredondas com Corte 251-200



Alicate para Descarnar Isolado 257-160



4 chaves de precisão + tampa



Tester 396-001

2 rolos de fita isolante



Chave de Parafusos Ponta Fenda Retas 360-025-075
360-040-100
360-055-125
360-065-150
360-080-175



Chave de Parafusos Phillips 361-PH0-060
361-PH1-080
361-PH2-100

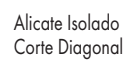

Alicate Isolado Corte Diagonal 255-160



Alicate Isolado Universal 250-180

JOGO DE CHAVES DE CAIXA ISOLADAS 20 PEÇAS



80 mm
320 mm
415 mm



10 · 11 · 12 · 13 · 14 · 16 · 17 · 18 · 19 · 21 · 22 · 24 · 27

- Chaves de Caixa com Bit
- Roquete de precisão L 250 mm
- Extensão 250 mm
- Chave em "T" L 200 mm

4 · 5 · 6 · 8 · L120 mm



Ref 5331-001

~~577,13 €~~ **339,49 €**

CHAVES DE PARAFUSOS SERIE INDUSTRIAL PLUS

- Poliuretano antiderrapante
- Poliamida de alta resistência
- Reforço duplo
- Vareta sextavada e Hexágono condutor 58 HRc

S2



MAIOR FIRMEZA

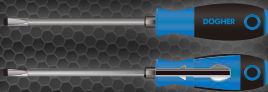

6 CHAVES DE PARAFUSOS SERIE INDUSTRIAL PLUS

Retã
3 · 4 · 5 · 6

PH1 · PH2

Ref 300-001

~~62,51 €~~ 35,85 €



CHAVES DE PARAFUSOS PROFISSIONAIS

Vareta circular
Punho bimaterial
56 HRc



5 CHAVES DE PARAFUSOS PROFISSIONAIS

CrMo



Retã
5,5 · 6,5

Ref 330-001

PH1 · PH2 · PH3

~~43,38 €~~ 25,51 €

7 CHAVES DE PARAFUSOS PROFISSIONAIS

CrMo



Fenda
Plana
3 · 4 · 5,5 · 6,5

Ref 330-003

PH0 · PH1 · PH2

~~49,02 €~~ 28,84 €

7 CHAVES DE PARAFUSOS PROFISSIONAIS

CrMo



Fenda
Plana
3 · 4 · 5,5 · 6,5

Ref 330-004

PZ0 · PZ1 · PZ2

~~50,53 €~~ 29,72 €

6 CHAVES DE PARAFUSOS PROFISSIONAIS

CrMo



Retã
2,5 · 3 · 3,5 · 4 · 5,5 · 6,5

Ref 331-001

~~41,23 €~~ 24,13 €

6 CHAVES DE PARAFUSOS PROFISSIONAIS

CrMo



Fenda
Plana
2,5 · 3 · 4 · 5,5 · 6,5 · 8

Ref 330-009

~~47,19 €~~ 27,62 €

6 CHAVES DE PARAFUSOS DE PANCADA PROFISSIONAIS

CrMo



Fenda
Plana
5,5 · 6,5 · 8

PH1 · PH2 · PH3

Ref 375-005

~~75,28 €~~ 44,06 €

CHAVES DE PARAFUSOS DE PRECIÇÃO

Vareta circular
Punho Bimaterial
56 HRc

CrMo



1,5 · 2 · 2,5 · 3

Ref 380-002

PH00 · PH0 · PH1

~~40,38 €~~ 23,75 €

7 CHAVES DE PARAFUSOS DE PRECIÇÃO



JOGO DE GANCHOS PARA A EXTRAÇÃO DE RETENTORES

6
Pcs



- Gancho com Forma de Garra
- Gancho com Forma Reta
- Gancho com Ponta a 90°
- Gancho em Ângulo de 90°
- Gancho para Extração O-Ring

Ref 330-101

~~68,63 €~~ 40,16 €

BITTS

DE IMPACTO

- Aço de alta tecnologia S2
- Máxima resistência à torção
- Alta tenacidade
- Geometria específica, oferece a máxima durabilidade

30 mm

1/4"

S2



BITTS DE IMPACTO

PONTA PHILLIPS

1/4"



	Ref		
PH2	2	427-PH2-2	11,87 € 6,99 €

BITTS DE IMPACTO

PONTA POZIDRIV

1/4"



	Ref		
PZ2	2	427-PZ2-2	11,87 € 6,99 €

KIT BITTS

E PORTA-BITTS

ADAPTADOR DE IMPACTO PARA CHAVES DE CAIXA



	Ref		
1/4	561-021	9,23 €	5,43 €
3/8	594-019	10,56 €	6,21 €
1/2	594-021	12,01 €	7,06 €



KIT DE 3 ADAPTADORES DE IMPACTO PARA CHAVES DE CAIXA



1/4"			
3/8"			
1/2"			
	1/4"		
	Ref 594-100		
		27,78 €	16,34 €

ADAPTADOR SDA PLUS PARA CHAVES DE CAIXA



	Ref		
1/4	509-035	10,32 €	6,07 €
1/2	543-035	14,73 €	8,66 €



KIT BITTS DE CAIXA MAGNÉTICOS

3 Bits de Caixa Magnéticos 50 mm 8 · 10 · 13



	Ref 440-001		
		20,81 €	12,24 €

PORTA-BITTS MAGNÉTICO DE IMPACTO COM ANEL



Ø 15



L mm	Ref		
60	1	443-002	19,22 € 11,31 €

KIT DE BITTS DE CAIXA MAGNÉTICOS E PORTA-BITTS

5 Bits de Caixa Mag. 50 mm 6 · 7 · 8 · 10 · 13
2 Porta-bits 50-74 mm



	Ref 440-007		
		56,74 €	33,37 €

PORTA-BITTS MAGNÉTICO SDS PLUS DE IMPACTO COM ANEL



L mm	Ref		
78	1	445-001	15,76 € 9,26 €

PORTA-BITTS MAGNÉTICO COM ANEL



L mm	Ref		
50	1	443-050	6,42 € 3,76 €
74	1	443-074	11,43 € 6,72 €

EXTENSOR FLEXÍVEL

1/4" 1/4" 300 mm



Ref 444-001

~~32,53 €~~ 19,13 €



PORTA-PONTAS EM ÂNGULO PARA 1/4"

- Válido para pontas e brocas sextavadas.
- Desenhado para trabalhar em espaços reduzidos.
- Recomenda-se usar só em berbequins de bateria.

1/4" 140 mm 55 Nm Max.



NOVIDADE

Ref 443-011

~~79,32 €~~ 46,66 €

PORTA PONTAS

1/4" 45 Nm Max.



Ref 443-010

~~37,36 €~~ 21,97 €



PORTA PONTAS

1/4"



Ref 443-001

- Válido para pontas e brocas sextavadas.

~~32,31 €~~ 19,00 €

CHAVE DE BITS ARTICULADA COM ROQUETE

- Reversível
- Punho ergonômico bimatetrial
- Bola de retenção de segurança
- Botão de desbloqueio

1/4" CrV



180mm Ref 343-007

~~19,89 €~~ 11,69 €

58 PECAS

BITS E PORTA-BITS

- 3 · 4 · 4,5 · 5 · 6 · 7 · 8
- PH0 · PH1 · PH2 · PH3
- PZ0 · PZ1 · PZ2 · PZ3
- T5 · T6
- TS7 · TS8 · TS9 · TS10 · TS15
- TS20 · TS25 · TS30 · TS40
- HX1,5
- HXS2,0 · HXS2,5 · HXS3,0
- HXS4,0 · HXS5,0 · HXS6,0
- 1 · 2 · 3
- XZN4 · XZN5 · XZN6 · XZN8

- R0 · R1 · R2 · R3
- TW1 · TW2 · TW3 · TW4
- TQ06 · TQ08 · TQ10
- 4 · 6 · 8 · 10

S2

Adaptador 1/4" ◀ ▶ 1/4" (509-030)

Porta-bits magnético com anel · 60 mm
Chave de bit Ref. 343-007







Ref 438-008

~~71,19 €~~ 41,88 €

32 PEÇAS

BITS E PORTA-BITS

-  T06 · T07 · T08 · T09 · T10 · T15
T20 · T25 · T27 · T30 · T40
-  HX3 · HX4 · HX5 · HX6
-  3 · 4 · 5 · 6 · 7
-  PH0 · PH1 · PH2 (x3) · PH3
-  PZ0 · PZ1 · PZ2 · PZ3

Adaptador 1/4"  1/4" (509-030)
Porta-bits magnético com anel · 60 mm



1/4" 25 mm

Ref 438-001

~~41,94 €~~ 24,66 €

JOGO DE CHAVES COM VARETAS INTERMUTÁVEIS











1 Punho porta-varetas profissional
10 Varetas intermutáveis com 2 pontas de aparafusar diferentes

20 chaves em 1

· Varetas de dupla ponta

A solução para o aparafusamento no seu bolso !!!



-  3 · 4
-  PH0 · PH1
-  PZ0 · PZ1
-  T10 · T15
-  HX2 · HX3
-  5,5 · 6,35
-  PH2 · PZ2
-  PZ/FL1 · PZ/FL2
-  T20 · T25
-  HX4 · HX5











1/4"

Ref 330-050

~~70,99 €~~ 41,75 €

51 PEÇAS

CHAVE DE PARAFUSOS DE PRECISÃO MAIS BITS

-  1 · 1,5 · 2 · 2,5 · 3 · 3,5 · 4
-  PH000 · PH00 · PH0 · PH1
-  PZ000 · PZ00
PZ0 · PZ1 · PZ2
-  T3 · T4 · T5 · T6 · T7
T8 · T9 · T10 · T15 · T20
-  TS7 · TS8 · TS9 · TS10
TS15 · TS20
-  HX0,7 · HX0,9 · HX1,3
HX1,5 · HX2,0 · HX2,5
HX3,0 · HX3,5 · HX4,0
-  HS2,0 · HS2,5
HS3,0 · HS4,0
-  HR1,5 · HR2,0 · HR2,5
HR3,0 · HR4,0

Ref 380-005

~~75,67 €~~ 44,50 €



DEDO MAGNÉTICO FLEXÍVEL

680 mm 27" 1kg



Ref 343-021

~~40,28 €~~ 23,57 €

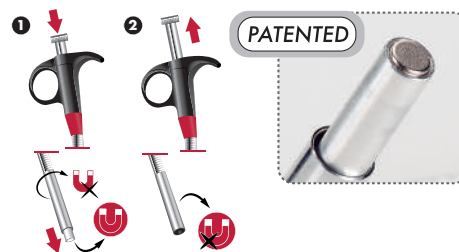

• Cobertura Anti-Magnética.

PINÇA FLEXÍVEL DE 3 GARRAS

700 mm 27,5" 1,2kg

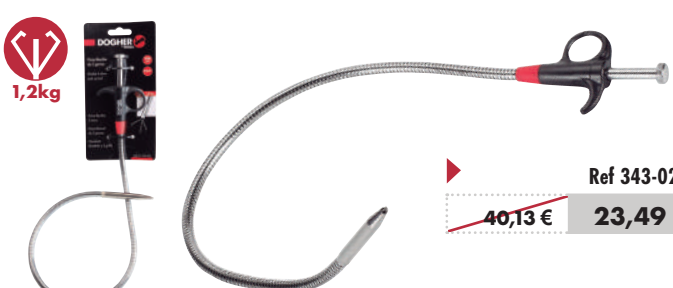

Ref 343-026

~~40,13 €~~ 23,49 €

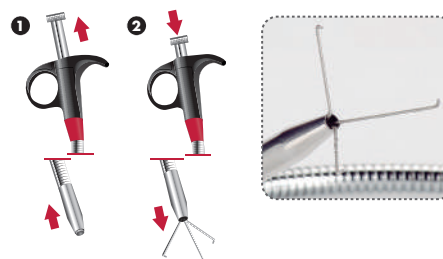

CHAVES AJUSTÁVEL

CrV

- Ajuste nas bocas com a máxima precisão
- Aperto mais rígido
- Parafuso de arrasto preciso, sem folgas
- Ângulo de 15°, aumenta o par com menor esforço

15°



CHAVE AJUSTÁVEL MOLETA LATERAL



L mm	L"	mm	Ref	€	€
▶ 150	6	24	491-150	33,27 €	19,57 €
200	8	29	491-200	37,13 €	21,84 €
250	10	33	491-250	45,85 €	26,97 €
300	12	38	491-300	58,04 €	34,15 €
400	16	50	491-400	96,53 €	56,78 €
500	20	62	491-500	175,24 €	103,09 € ▶

CHAVE AJUSTÁVEL MOLETA CENTRAL PRO



L mm	L"	mm	Ref	€	€
▶ 100	4	17	493-100	23,33 €	13,38 €
150	6	24	493-150	24,02 €	13,76 €
200	8	29	493-200	27,57 €	15,81 €
250	10	33	493-250	33,71 €	19,34 €
300	12	38	493-300	44,19 €	25,35 €
380	15	50	493-380	75,18 €	43,12 €
450	18	60	493-450	118,05 €	67,71 €
600	24	70	493-600	293,29 €	168,21 € ▶

CHAVE AJUSTÁVEL GRANDE ABERTURA GRANDE ABERTURA



L mm	L"	mm	Ref	€	€
▶ 150	6	34	492-150	34,47 €	19,76 €
200	8	38	492-200	37,39 €	21,44 €
250	10	50	492-250	45,80 €	26,26 €
NOVIDADE 300	12	60	492-300	59,32 €	34,90 € ▶

CHAVE AJUSTÁVEL MOLETA CENTRAL STD



L mm	L"	mm	Ref	€	€
▶ 100	4	13	4930-100	16,37 €	9,40 €
150	6	19	4930-150	16,53 €	9,49 €
200	8	24	4930-200	19,09 €	10,94 €
250	10	28	4930-250	23,97 €	13,74 €
300	12	34	4930-300	30,95 €	17,75 €
380	15	43	4930-380	55,60 €	31,88 €
450	18	52	4930-450	85,48 €	49,03 €
600	24	62	4930-600	180,85 €	103,72 € ▶

CHAVE AJUSTÁVEL GRANDE ABERTURA EXTRACURTA



L mm	L"	mm	Ref	€	€
▶ 140	6	32	492-014	39,42 €	23,19 €
160	6	43	492-016	46,90 €	27,59 € ▶

CHAVE AJUSTÁVEL GRANDE ABERTURA BOCA REDUZIDA



L mm	L"	mm	Ref	€	€
▶ 150	6	34	492-006	39,06 €	22,97 €
200	8	38	492-008	42,36 €	24,91 € ▶

CHAVE AJUSTÁVEL



L mm	L"	mm	Ref	€	€
▶ 200	8	38,1	493-008	42,18 €	24,81 € ▶

CHAVE AJUSTÁVEL

CrV **Alligator** 200 mm • 8" 32 mm M3-M10 CrV

▶	Ref 4931-200	40,98 €	24,10 €
---	--------------	--------------------	---------

CHAVES DE BOCAS DUPLA BOCA ABERTA



8 CHAVES DE BOCAS DUPLA BOCA ABERTA

6x7 · 8x9 · 10x11 · 12x13 · 14x15 · 16x17 · 18x19 · 20x22



390 x 300 mm

Ref 450-001
~~77,05 €~~ 45,32 €



Ref 450-018
~~79,05 €~~ 46,50 €

10 CHAVES DE BOCAS DUPLA BOCA ABERTA

6x7 · 8x9 · 10x11 · 12x13 · 14x15
16x17 · 18x19 · 20x22 · 21x23 · 24x27



Ref 450-020
~~111,48 €~~ 65,57 €

12 CHAVES DE BOCAS DUPLA BOCA ABERTA

6x7 · 8x9 · 10x11 · 12x13 · 14x15 · 16x17 · 18x19 · 20x22 · 21x23 · 24x27 · 25x28
· 30x32



Ref 450-002
~~157,50 €~~ 92,65 €

620 x 350 mm

CHAVES TUBULARES DUPLAS

8 CHAVES TUBULARES DUPLAS

6x7 · 8x9 · 10x11 · 12x13 · 14x15 · 16x17 · 18x19 · 20x22



430 x 380 mm

Ref 460-002
~~178,03 €~~ 102,10 €

CrV



12 CHAVES TUBULARES DUPLAS

6x7 · 8x9 · 10x11 · 12x13 · 14x15 · 16x17
18x19 · 20x22 · 21x23 · 24x26 · 25x28 · 30x32



520 x 390 mm

Ref 460-004
~~363,46 €~~ 208,46 €

CHAVES DE LUNETAS 75°

8 CHAVES DE LUNETAS 75°

6x7 · 8x9 · 10x11 · 12x13 · 14x15 · 16x17 · 18x19 · 20x22



390 x 380 mm

Ref 453-002
~~139,57 €~~ 82,10 €

CrV



75° 75°

12 CHAVES DE LUNETAS 75°

6x7 · 8x9 · 10x11 · 12x13 · 14x15 · 16x17
18x19 · 20x22 · 21x23 · 24x27 · 25x28 · 30x32



620 x 480 mm

Ref 453-003
~~291,37 €~~ 171,40 €

CHAVES

BOCA/LUNETA

- Distribuição ótima das cargas
- Fixação rápida
- Máximo rendimento sem desgaste
- Diminuição dos danos em porcas e parafusos

- Maior vida útil da chave
- Máxima superfície de contato
- Distribuição homogênea do esforço

CrV



Efeito do esforço:

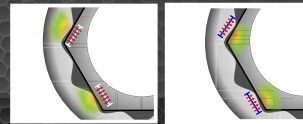

- Sobre a chave
- Sobre a porca

8 CHAVES

BOCA/LUNETA

8 · 10 · 11 · 12 · 13 · 14 · 17 · 19

Ref 451-018

~~89,54 €~~ 52,68 €



12 CHAVES

BOCA/LUNETA

8 · 9 · 10 · 11 · 12 · 13 · 14 · 15 · 16 · 17 · 18 · 19

Ref 451-022

~~132,80 €~~ 78,12 €



14 CHAVES

BOCA/LUNETA

8 · 9 · 10 · 11 · 12 · 13 · 14
17 · 19 · 22 · 24 · 27 · 30 · 32

Ref 451-002

~~228,23 €~~ 134,25 €



650 x 440 mm

17 CHAVES

BOCA/LUNETA

6 · 7 · 8 · 9 · 10 · 11 · 12 · 13 · 14 · 15
16 · 17 · 18 · 19 · 20 · 21 · 22

Ref 451-003

~~197,69 €~~ 110,47 €



470 x 450 mm

18 CHAVES

BOCA/LUNETA

8 · 9 · 10 · 11 · 12 · 13 · 14 · 15 · 16
18 · 19 · 22 · 23 · 24 · 26 · 27 · 30 · 32

650 x 480 mm

Ref 451-004

~~296,54 €~~ 174,43 €



24 CHAVES

BOCA/LUNETA

6 · 7 · 8 · 9 · 10 · 11 · 12 · 13 · 14 · 15 · 16 · 17
18 · 19 · 20 · 21 · 22 · 24 · 26 · 27 · 28 · 30 · 32 · 36

650 x 580 mm

Ref 451-005

~~425,68 €~~ 250,40 €



26 CHAVES

BOCA/LUNETA

6 · 7 · 8 · 9 · 10 · 11 · 12 · 13 · 14 · 15 · 16 · 17 · 18 · 19
20 · 21 · 22 · 23 · 24 · 25 · 26 · 27 · 28 · 29 · 30 · 32

650 x 500 mm

Ref 451-006

~~434,35 €~~ 255,50 €



CHAVES BOCA/ROQUETE REVERSÍVEL

CrV 72^{LS}

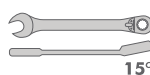

5 CHAVES BOCA/ROQUETE REVERSÍVEL

8 · 10 · 13 · 17 · 19

Ref 457-014

~~180,521 €~~ 106,18 €



7 CHAVES BOCA/ROQUETE REVERSÍVEL

10 · 12 · 13 · 14 · 15 · 17 · 19

Ref 457-001

~~255,65 €~~ 146,62 €



330 x 390 mm

8 CHAVES BOCA/ROQUETE REVERSÍVEL

8 · 10 · 11 · 12
13 · 14 · 17 · 19

Ref 457-018

~~278,48 €~~ 163,82 €



12 CHAVES BOCA/ROQUETE

NÃO REVERSÍVEL

8 · 9 · 10 · 11 · 12 · 13 · 14 · 15 · 16 · 17 · 18 · 19



Ref 4557-022

~~278,48 €~~ 163,81 €



5 CHAVES

BOCA/ROQUETE FLEXÍVEL

8 · 10 · 13 · 17 · 19



Ref 458-015

~~170,23 €~~ 97,65 €



8 CHAVES BOCA/ROQUETE

REVERSÍVEL STOPRING

8 · 10 · 11 · 12 · 13 · 14 · 17 · 19



Ref 4657-018

~~328,33 €~~ 197,07 €

NOVIDADE

CHAVES

DE ROQUETES 4 EM 1

CrV

mm mm Ref

10x13 17x19 475-10-19 ~~41,04 €~~ 24,15 €

72⁵



3 CHAVES

DE ROQUETES 4 EM 1

8x13: 8x10 12x13
9x15: 9x11 14x15
16x19: 16x17 18x19

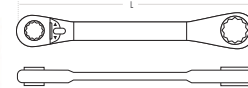

Ref 475-001

~~118,57 €~~ 68,01 €

220 x 330 mm

10 CHAVES

DE CACHIMBO 6X6



CrV



6 · 7 · 8 · 10 · 11 · 12 · 13 · 14 · 17 · 19

Ref 462-011

~~183,27 €~~ 105,10 €



ROQUETE

SUPERPROOF

CrV 72⁵



	L mm	Ref	
1/4"	145	510-006	46,79 € 27,51 €
1/2"	250	544-006	63,87 € 37,57 €

ROQUETES

CrV 72⁵ Roquete de precisão De 72 dentes



510-001/544-001

	L mm	Ref	
1/4"	108	510-002	24,65 € 14,13 €
	145	510-001	30,03 € 17,66 €



510-002/544-002

Serie curta disponível Especial para espaços reduzidos

	L mm	Ref	
1/2"	170	544-002	34,69 € 19,90 €
	250	544-001	52,09 € 30,63 €

CHAVES DINAMOMÉTRICAS

CHAVE DINAMOMÉTRICA PROFISSIONAL



N*m		L mm		Ref	Price	Price
1,5-6	0,05	210	1/4"	625-01-06	241,14 €	141,84 €
2-10	0,1	280	1/4"	625-02-10	256,95 €	151,15 €
10-50	0,25	330	1/4"	625-10-50	268,43 €	157,90 €
10-60	0,5	340	3/8"	626-10-60	283,13 €	166,56 €
20-100	0,5	435	1/2"	627-20-100	310,29 €	182,51 €
40-200	1	515	1/2"	627-40-210	317,00 €	186,47 €
80-400	2	615	1/2"	627-70-350	365,16 €	214,79 €
100-600	5	1050	3/4"	628-100-500	1.109,41 €	652,59 €
200-1000	5	1250	3/4"	628-200-1000	1.565,41 €	920,82 €
300-1.500	10	1850	1"	629-300-1500	2.779,30 €	1.634,88 €

CHAVE DINAMOMÉTRICA STANDARD



N*m		L mm		Ref	Price	Price
5-25	0,1	280	1/4"	630-05-25	180,93 €	106,43 €
70-340	3	570	1/2"	632-70-350	353,30 €	207,82 €

Pode apertar-se tanto em rotação à esquerda como à direita

CHAVE DINAMOMÉTRICA ISOLADA

DIN EN/IEC 60900



N*m		L mm		Ref	Price	Price
5-25	0,2	290	3/8"	6031-05-25	725,36 €	426,68 €
10-50	0,5	290	1/2"	6032-10-50	815,36 €	479,62 €



NOVIDADE

MULTIPLICADOR DO TORQUE EN MALA



±5%

• Inclui Pé de reação, Barra Suporte e Vareta para Desbloqueio

IN	OUT	Prec.		IN (Max) Nm	OUT (Max) Nm	g.	Ref	Price	Price
1/2"	3/4"	±5 %	1 : 5	300	1500	6500	645-001	1.099,45 €	646,74 €
3/4"	1"	±5 %	1 : 5	540	2700	6500	645-002	1.205,59 €	709,17 €

MULTIPLICADOR DO TORQUE ESPECIAL PARA RODAS DE CAMINHÕES



IN	OUT	Prec.		OUT (Max) Nm	Ref	Price	Price
1"	1"	±5 %	1 : 56	3200	645-003	743,00 €	437,06 €

• Pé de reação Integrado no Corpo do Multiplicador

Nota: Este multiplicador do Torque é só para soltar as porcas, em especial dos caminhões e veículos industriais de todo tipo.

CHAVES DE CAIXA CONJUNTOS DE CHAVES DE CAIXA

17 PEÇAS 1/4"

CHAVES DE CAIXA SEXTAVADAS



4 · 4,5 · 5 · 5,5 · 6 · 7 · 8 · 9
10 · 11 · 12 · 13 · 14

Roquete de 72 dentes

Articulação universal

Extensor: 50 mm

Chave com tripla quadra



Ref

500-001 ~~96,67 €~~ **55,46 €** 260 x 167 x 62 mm

34 PEÇAS 1/4"

CHAVES DE CAIXA SEXTAVADAS



4 · 4,5 · 5 · 5,5 · 6 · 7 · 8 · 9 · 10 · 11 · 12 · 13 · 14

1/4" · Bits

T10 · T15 · T20 · T25

4 · 5,5 · 6,5

HX3 · HX4 · HX5 · HX6

PH1 · PH2 · PH3

Roquete de precisão de 72 dentes

Articulação universal

Extensor: 50 mm

Extensor flexível 145 mm

Chave com tripla quadra

Porta bits com quadra de arrasto 1/4"

Adaptador para espaços reduzidos



Ref

500-002 ~~138,34 €~~ **79,34 €** 260 x 167 x 62 mm

47 PEÇAS 1/4"

CHAVES DE CAIXA SEXTAVADAS



4 · 4,5 · 5 · 5,5 · 6 · 7 · 8 · 9 · 10 · 11 · 12 · 13 · 14
Serie Longa: 8 · 10 · 11 · 13

Chaves de caixa com Pontas T10 · T15 · T20 · T25 · T30 · T40

4 · 5,5 · 6,5

HX3 · HX4 · HX5 · HX6 · HX7 · HX8

PH1 · PH2 · PH3

PZ1 · PZ2 · PZ3

Roquete de 72 dentes

Articulação universal

Extensor: 50 e 100 mm

Chave

Cabo correção em "T"

Chaves Allen 1,5 · 2 · 2,5



Ref

500-003 ~~239,83 €~~ **126,97 €**

260 x 167 x 62 mm

16 PEÇAS 3/8"

CHAVES DE CAIXA SEXTAVADAS



8 · 9 · 10 · 11 · 12 · 13
14 · 15 · 16 · 17 · 18 · 19

Roquete de precisão de 72 dentes

Articulação universal

Extensor: 75 mm

Adaptador para espaços reduzidos



Ref

516-001 ~~123,76 €~~ **65,53 €** 260 x 167 x 62 mm

34 PEÇAS 3/8"

CHAVES DE CAIXA SEXTAVADAS



6 · 8 · 10 · 11 · 12 · 13 · 14 · 15 · 16 · 17 · 18 · 19

1/4" · Chaves de caixa com bits

T10 · T15 · T20 · T25 · T27 · T30 · T40

PH0 · PH1 · PH2 · PH3

HX3 · HX4 · HX5 · HX6

Roquete de precisão de 72 dentes

Articulação universal

Extensores: 75 y 150 mm

Chave

Cabo correção em "T"

Adaptador 1/4" - 3/8"



Ref

516-003 ~~230,08 €~~ **121,81 €** 260 x 167 x 62 mm

CHAVES DE CAIXA CONJUNTOS DE CHAVES DE CAIXA

14 PEÇAS 1/2"

CHAVES DE CAIXA SEXTAVADAS

- 10 · 11 · 12 · 13 · 14 · 15
 - 16 · 17 · 18 · 19 · 21 · 22
- Roquete de precisão de 72 dentes
Articulação universal

Ref
531-001 ~~123,54 €~~ **70,85 €**
260 x 167 x 62 mm



41 PEÇAS 1/2"

CHAVES DE CAIXA SEXTAVADAS E 12 FACES

- 8 · 9 · 10 · 11 · 12 · 13 · 14 · 15 · 16 · 17 · 18 · 19 · 21 · 22 · 24 · 27 · 30 · 32

- 5/16" · Bits
 - PH3 · PH4
 - PZ3 · PZ4
 - T40 · T45 · T50 · T55 · T60
 - HX7 · HX8 · HX10 · HX12
 - 8 · 10 · 12
- Roquete de precisão de 72 dentes
Articulação universal
Extensores: 125 e 250 mm
Porta bits com quadra de arrasto 5/16"-1/2"
Adaptador tripla função 3/8"- 1/2"
Adaptador para espaços reduzidos

Ref
531-003 ~~256,59 €~~ **147,18 €**
530-003 ~~256,59 €~~ **147,18 €**
385 x 280 x 87 mm



16 PEÇAS 3/4"

CHAVES DE CAIXA SEXTAVADAS

- 19 · 22 · 23 · 24 · 27 · 30 · 32 · 36 · 38 · 41 · 46 · 50
- Roquete de precisão de 24 dentes -500 mm
Extensores: 100 e 200 mm
Cabo correção em "T"

Ref
549-001 ~~644,32 €~~ **341,10 €**



76 PEÇAS 1/4" E 1/2"

CHAVES DE CAIXA SEXTAVADAS

- 4 · 4,5 · 5 · 5,5 · 6 · 7 · 8 · 9 · 10 · 11 · 13

- 1/4" · Bits
- PH0 · PH1 · PH2 · PH3
- PZ2 · PZ3
- T10 · T15 · T20 · T25 · T27 · T30
- HX2 · HX3 · HX4 · HX5 · HX6 · HX7
- 3 · 4,5 · 5,5 · 6,5

- Chaves de Caixa
- 10 · 11 · 12 · 13 · 14 · 15 · 16 · 17 · 19 · 21 · 24 · 27 · 30 · 32

- 5/16" · Bits
- PH3 · PH4
- PZ3 · PZ4
- T40 · T45 · T50 · T55 · T60
- HX8 · HX10 · HX12
- 8 · 10 · 12

- Roquete de precisão de 72 dentes 1/4" e 1/2"
- Articulação universal 1/4" e 1/2"
- Extensores 1/4" e 1/2": 50 e 100-125 e 250 mm
- Chave com tripla quadra 1/4"
- Porta bits com quadra de arrasto 1/4" e 1/2"
- 1/4" > 5/16" > 1/2"
- Adaptador para espaços reduzidos 1/4" e 1/2"
- Adaptador tripla função 1/2"
- 3/8" > 1/2"



440 x 305 x 92 mm

Ref
500-025 ~~364,86 €~~ **193,16 €**

94 PEÇAS 1/4" E 1/2"

CHAVES DE CAIXA SEXTAVADAS

- 10 · 11 · 12 · 13 · 14 · 15 · 16 · 17 · 18 · 19 · 20 · 21 · 22 · 24 · 27 · 30 · 32
- Serie longa: 14 · 15 · 17 · 19 Para as velas: 16 · 21

- 5/16" Bits
- PH3 · PH4
- PZ3 · PZ4
- T40 · T45 · T50 · T55
- HX8 · HX10 · HX12 · HX14
- 8 · 10 · 12

- Chaves de Caixa
- 6 · 7 · 8 · 9 · 10 · 11 · 12 · 13

- Chaves de caixa com bits
- PH1 · PH2
- PZ1 · PZ2
- T8 · T10 · T15 · T20 · T25 · T30
- HX3 · HX4 · HX5 · HX6
- 4 · 5,5 · 7

- Roquetes de 72 dentes 1/4" e 1/2"
- Articulação universal 1/4" e 1/2"
- Extensores: 50 e 100-125 e 250 mm 1/4" e 1/2"
- Chave 1/4"
- Extensor flexível 1/4"
- Cabo Correção em "T" 1/4"
- Porta bits 5/16" > 1/2"
- Adaptador 3/8" > 1/2"
- Chaves macho 1,5 · 2 · 2,5



380 x 300 x 84 mm

Ref
500-030 ~~148,29 €~~ **87,24 €**

151 PEÇAS 1/4", 3/8" E 1/2"

CHAVES DE CAIXA SEXTAVADAS



- ▶ **1/4"**
 - 4 · 4,5 · 5 · 5,5 · 6 · 7 · 8 · 9 · 10 · 11 · 12 · 13 · 14
 - Serie longa: 4 · 5 · 6 · 7 · 8 · 9 · 10
 - ▶ **1/4"** T4 · T5 · T6 · T7 · T8

- Chaves de caixa com bits
 - ▶ **1/4"** PH0 · PH1 · PH2
 - ▶ **3/8"** PH3 · PH4
 - ▶ **1/2"** PH5 · PH6
 - ▶ **1/4"** PZ0 · PZ1 · PZ2
 - ▶ **3/8"** PZ3 · PZ4
 - ▶ **1/2"** PZ5 · PZ6
 - ▶ **1/4"** T8 · T9 · T10 · T15 · T20 · T25 · T27 · T30
 - ▶ **3/8"** T40 · T45 · T50 · T55 · T60 · T70
 - ▶ **1/2"** T10 · T11 · T12 · T14 · T16 · T18

- 10 · 11 · 12 · 13 · 14 · 15 · 16 · 17 · 18 · 19 Para as velas: 18
- Serie longa: 10 · 11 · 12 · 13 · 14 · 15
- ▶ **3/8"** T10 · T11 · T12 · T14 · T16 · T18

- 10 · 11 · 12 · 13 · 14 · 15 · 16 · 17 · 18 · 19 · 20 · 21 · 22 · 24 · 27 · 30 · 32
- Serie longa: 16 · 17 · 18 · 19 · 22 Para as velas: 16 · 21
- ▶ **1/2"** T20 · T24

- 5/16" Bits
 - ▶ **1/4"** PH3 · PH4
 - ▶ **3/8"** PH5 · PH6
 - ▶ **1/2"** PH7 · PH8
 - ▶ **1/4"** PZ3 · PZ4
 - ▶ **3/8"** PZ5 · PZ6
 - ▶ **1/2"** PZ7 · PZ8
 - ▶ **1/4"** T40 · T45 · T50 · T55 · T60 · T70
 - ▶ **3/8"** T40 · T45 · T50 · T55 · T60 · T70
 - ▶ **1/2"** T40 · T45 · T50 · T55 · T60 · T70

3 roquetes de 72 dentes 1/4", 3/8" e 1/2"
 Articulação universal 1/4", 3/8" e 1/2"
 Extensores 1/4", 3/8" e 1/2": 50 e 100 - 125 - 125 e 250
 Chave 1/4"
 Cabo corredizo em "T" 1/4"
 Adaptador tripla função 1/2" 3/8" ▶ 1/2"
 Porta bits com quadra de arrasto 1/2" e 3/8" 5/16" ▶ 1/2" / 3/8"
 Chaves macho 1,27 · 1,5 · 2 · 2,5 · 3 · 4 · 5 ▶ 1/2"



Ref **500-027** ~~898,64 €~~ **475,75 €** ▶ 435 x 305 x 95 mm

8 PEÇAS 3/4"

CHAVES DE CAIXA SÉRIE LONGA + ADAPTADOR AMPLIADOR DE IMPACTO

19 · 22 · 24 · 27 · 30 · 32 · 36



3/4" ▶ **3/4"** ▶ **1/2"** (594-026) ▶ Ref **579-001** ~~400,82 €~~ **234,60 €** ▶

CHAVES DE CAIXA DE IMPACTO 1/2" ESPECIAL JANTES



17 · 19 · 21



Ref **575-001** ~~39,78 €~~ **23,40 €**

10 CHAVES DE CAIXA IMPACT

10 · 13 · 15 · 16 · 17 · 18 · 19 · 21 · 22 · 24



Ref **570-001**
~~122,07 €~~ **71,81 €** NOVIDADE



9 CHAVES DE CAIXA IMPACT

19 · 22 · 24 · 27 · 30 · 32 · 36 · 41 · 46



Ref **578-001**
~~251,59 €~~ **148,00 €** NOVIDADE



Ref **571-001** SÉRIE LONGA
~~220,27 €~~ **129,57 €** NOVIDADE

Ref **579-002** SÉRIE LONGA
~~509,29 €~~ **299,59 €** NOVIDADE

9 CHAVES DE CAIXA PARA PORCAS KM

1/2" L 60mm - KM4 · KM5 · KM6 · KM7 · KM8

3/4" L 68mm - KM9 · KM10 · KM11 · KM12



Ref **598-001**
~~849,60 €~~ **499,76 €** NOVIDADE



JOGOS

DE CHAVES UMBRACO

Cr-V

CHAVES

9 CHAVES

UMBRACO TORX

T10 · T15 · T20 · T25
T27 · T30 · T40 · T45 · T50

Ref 606-009
~~32,53 €~~ 19,13 €

Ref 608-009
~~47,83 €~~ 28,13 €

Serie Extra Longa

9 CHAVES

UMBRACO TORX SEGURANÇA

TS10 · TS15 · TS20 · TS25 · TS27 ·
TS30 · TS40 · TS45 · TS50

Ref 609-009
~~39,50 €~~ 23,24 €

Ref 611-009
~~55,86 €~~ 32,87 €

Serie Extra Longa

9 CHAVES

UMBRACO SEXTAVADAS

1,5 · 2 · 2,5 · 3
4 · 5 · 6 · 8 · 10 mm

Ref 600-009
~~16,30 €~~ 9,34 €

Ref 602-009
~~24,58 €~~ 14,46 €

Serie Extra Longa



9 CHAVES

UMBRACO SEXTAVADAS REDONDAS

1,5 · 2 · 2,5 · 3 · 4 · 5 · 6 · 8 · 10 mm



Ref 603-009
~~21,83 €~~ 12,84 €

Serie Extra Longa



Ref 605-009
~~33,73 €~~ 19,84 €



Ref 605-069
~~40,70 €~~ 23,94 €



Ref 607-079
~~31,77 €~~ 18,68 €



Ref 610-079
~~39,77 €~~ 23,35 €

15 CHAVES

UMBRACO SEXTAVADAS REDONDAS

1,27 · 1,5 · 2 · 2,5 · 3 · 3,5
4 · 4,5 · 5 · 5,5 · 6 · 7 · 8
9 · 10 mm

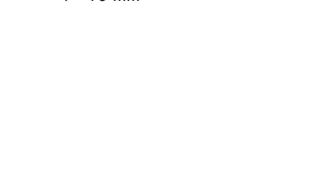

Ref 605-089
~~54,72 €~~ 32,19 €

Serie Extra Longa

9 CHAVES

UMBRACO TORX

T10 · T15 · T20 · T25
T27 · T30 · T40 · T45 · T50

NOVIDADE

Ref 608-069
~~45,36 €~~ 26,68 €

Serie Extra Longa



9 CHAVES

SEXTAVADAS DE SEGURANÇA

1,5 · 2 · 2,5
3 · 4 · 5 · 6 · 8 · 10 mm

NOVIDADE

Ref 607-089
~~33,73 €~~ 19,84 €

Serie Extra Longa



NIVEIS

NIVEL TUBULAR MAGNÉTICO 3 AMPOLAS

- AI
- 3 Ampolas 45° · 90° · 180°
- Magnetizado



L mm	Ref	22,90 €	13,47 €
400	783-02-400	29,73 €	17,49 €
600	783-02-600	32,58 €	19,16 €
1000	783-02-1000	40,28 €	23,69 €
1200	783-02-1200	51,15 €	30,09 €
1800	783-02-1800	76,50 €	45,00 €

NIVEL TRAPEZOIDAL 2 AMPOLAS

- AI
- 0,5 mm/m
- 2 Ampolas 90° · 180°



L mm	Ref	20,36 €	11,97 €
400	784-01-400	26,45 € <td>15,54 €</td>	15,54 €
600	784-01-600		



NIVEL TORPEDO TUBULAR 3 AMPOLAS

- AI
- 0,5 mm/m
- 3 Ampolas 45° · 90° · 180°
- Proteção Anti-choque

L mm	Ref	25,74 €	15,13 €
250	785-001		



PINÇA AMPERIMÉTRICA DIGITAL

- Mede voltagem CA e CC, intensidades, continuidade e resistência.
- Proteção contra sobrecargas.
- Função de bloqueio.
- Continuidade audível.
- Indicador de bateria baixa.
- Tela LCD.
- Inclui pontas de proba isoladas 10A e capa.
- Precisa de uma pilha de 9V.
- IEC 61010
- Grau de Poluição II



Ref 795-001	46,94 €	27,62 €
-------------	--------------------	---------

MULTÍMETRO DIGITAL

- Mede voltagem Ca e CC, intensidades, continuidade e resistências.
- Comprova diodos e transistores NPN e PNP.
- Inclui pontas de proba isoladas.
- Tela LCD.
- Precisa de pilha de 9V (não incluída).
- IEC 61010
- Grau de Poluição II



Ref 795-002	41,59 €	24,47 €
-------------	--------------------	---------

TESTADOR DE TENSÃO E VOLTAGEM

- 3 in 1
- CAT II 600V
- V ~ 150V · 300V · 500V
- V ~ 110V · 220V · 380V
- 900 mm de cabo.
- Desenhado para trabalhar em T° entre 5°C - 40°C.
- Altitude até 2.000 m.
- IEC 61010
- Grau de Poluição II

900 mm

Ref 795-003

17,05 €	10,03 €
--------------------	---------



TESTADOR DE CABOS DE REDE

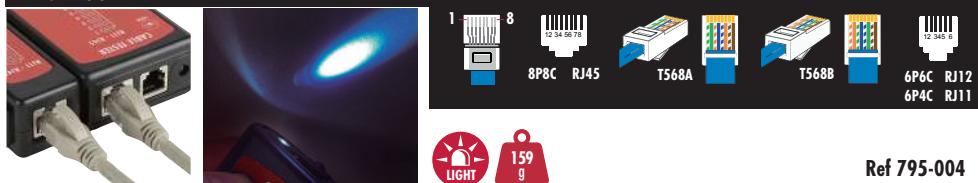

- LIGHT
- 159 g

NOVIDADE

Ref 795-004

37,36 €	21,98 €
--------------------	---------



FITAS MÉTRICAS PROFISSIONAIS

- Fita métrica metálica
- Botão de bloqueio manual
- Gama de proteção anti choque
- Correia de segurança incluída

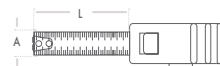

FITA MÉTRICA DUPLA FACE

Class II



- Fita de dupla face.

L m	A mm	Ref	8,88 €	5,22 €
3	16	771-03		
5	19	771-05	13,23 €	7,78 €

FITA MÉTRICA STD

Class II



L m	A mm	Ref	5,39 €	3,16 €
3	16	778-03		
5	19	778-05	7,29 €	4,29 €

FITA MÉTRICA FIBRA DE VIDRO

Class III



L m	A mm	Ref	27,32 €	16,07 €
30	13	779-030		
50	13	779-050	31,83 €	18,72 €

FITA MÉTRICA FIBRA DE VIDRO

Class III



- Velocidade de remoção da fita



L m	A mm	Ref	40,38 €	23,75 €
30	15	780-030		
50	15	780-050	55,65 €	32,74 €

Fita de dupla face

ESQUADRO INOXIDÁVEL PROFISSIONAL

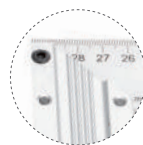

L mm	A mm	B mm	Ref	18,10 €	10,65 €
250	40	1	793-01-250		
300	40	1	793-01-300	20,66 €	12,15 €
350	40	1	793-01-350	21,14 €	12,43 €
400	40	1	793-01-400	21,92 €	12,90 €

PAQUÍMETRO DIGITAL

0,01 mm



Inclui Manual de Instruções
Mede em milímetros e polegadas.

Inox



mm	Ref	92,20 €	54,24 €
0 ~ 150	797-150		

PERCUSSÃO

MARTELOS

MARTELOS DE BATENTES UPE ANTI-RECUO PUNHO HICKORY

Ø mm	Ref	36,19 €	21,29 €
35	740-35	47,78 €	28,10 €
50	740-50	63,17 €	37,16 € ▶

UPE



• Batente de Substituição

MARTELOS DE BATENTES UPE PUNHO HICKORY

Ø mm	Ref	32,57 €	19,16 €
35	7331-35	42,93 €	25,25 €
50	7331-50	56,86 €	33,44 € ▶

UPE



• Batente de Substituição

MARTELOS DE BATENTES PU ANTI-RECUO PUNHO METÁLICO

Ø mm	Ref	42,56 €	25,03 €
35	7310-35	58,49 €	34,40 €
50	7310-50	68,70 €	40,41 € ▶

PU



• Batente de Substituição

MARTELOS ALEMÃES

g	A mm	L mm	Ref	17,35 €	10,21 €
200	20	270	707-200	20,47 €	12,04 €
300	23	305	707-300	26,01 €	15,29 €
500	27	335	707-500	34,69 €	20,41 €
800	33	365	707-800	38,12 €	22,43 €
1000	36	365	707-1000	52,06 €	30,62 € ▶
1500	43	395	707-1500		

NOVIDADE



MARTELO DE REBITE PUNHO FIBRA DE VIDRO

g	A mm	L mm	Ref	18,36 €	10,79 €
100	18	270	703-100	19,93 €	11,72 €
135	20	265	703-135	21,72 €	12,78 €
320	25	290	703-320	22,89 €	13,47 €
420	30	335	703-420	23,88 €	14,04 € ▶



MARTELOS PARA COFRAGEM PUNHO FIBRA DE VIDRO



Imã para o ajuste do prego



g	L mm	Ref	33,45 €	19,68 € ▶
700	500	711-700		

MARTELOS DE BOLA PUNHO HICKORY

	g	A mm	L mm	Ref	17,52 €	10,31 €
B	340	28	320	700-340	21,18 €	12,46 €
C	455	30	360	700-455	24,04 €	14,13 €
D	560	32	350	700-560	26,65 €	15,68 €
E	680	34	375	700-680	28,84 €	16,96 €
F	910	38	405	700-910	32,00 €	18,82 €
G	1130	40	410	700-1130	32,66 €	19,21 € ▶



MARTELOS DE BOLA PUNHO FIBRA DE VIDRO

	g	A mm	L mm	Ref	28,05 €	16,41 €
B	340	28	310	701-340	29,10 €	17,12 €
C	455	30	305	701-455	31,76 €	18,68 €
D	560	32	315	701-560	34,65 €	20,37 €
E	680	34	340	701-680	40,68 €	23,93 €
F	910	38	370	701-910	47,98 €	28,09 €
G	1130	40	375	701-1130	50,23 €	29,54 € ▶



PERCUSSÃO

MARTELOS

MACOS PARA COFRAGEM

PUNHO FIBRA DE VIDRO

g	L mm	Ref	55,96 €	32,91 €
▶ 3000	900	713-3000	55,96 €	32,91 €
4000	900	713-4000	70,64 €	41,56 €
5000	900	713-5000	80,10 €	47,12 €
▶ NOVIDADE 6000	900	713-6000	90,10 €	53,00 € ▶



MARRETAS DE PEDREIRO

PUNHO FIBRA DE VIDRO

g	L mm	Ref	27,68 €	16,28 €	NOVIDADE
▶ 700	250	705-700	27,68 €	16,28 €	NOVIDADE
1000	250	705-1000	28,51 €	16,76 €	
1250	250	705-1250	31,72 €	18,66 €	
1400	290	705-1400	33,25 €	19,56 €	NOVIDADE



PICARETA PÁ-MACHADO

PUNHO FIBRA DE VIDRO

g	L mm	Ref	30,76 €	18,09 €
▶ 550	380	717-550	30,76 €	18,09 €
650	380	717-650	34,79 €	20,47 € ▶



MACOS DE BORRACHA

PUNHO HICKORY

g	Ø mm	L mm	Ref	14,89 €	8,76 €
685	60	330	736-685	14,89 €	8,76 €
920	65	340	736-920	18,12 €	10,66 € ▶



PICARETA DE PEDREIRO

PUNHO FIBRA DE VIDRO

g	L mm	Ref	38,12 €	22,41 €
▶ 700	380	715-700	38,12 €	22,41 € ▶



MARTELO

PARA ARDÓSIA

g	L mm	Ref	20,09 €	11,82 €
▶ 400	315	715-010	20,09 €	11,82 € ▶



PICARETA DE SOLDADOR

PUNHO TUBULAR

g	L mm	Ref	19,37 €	11,40 €
▶ 500	300	715-001	19,37 €	11,40 € ▶



CABEÇA

DE PICARETA



g	Ref	32,72 €	19,15 €
▶ 2500	721-2500	32,72 €	19,15 €
3000	721-3000	37,82 €	22,13 € ▶

PUNHO

HICKORY PARA PICARETA

L mm	Ref	12,51 €	7,32 €
▶ 900	722H-900	12,51 €	7,32 € ▶



PUNHO

FIBRA DE VIDRO PARA PICARETA

L mm	Ref	26,30 €	15,40 €
▶ 900	723H-900	26,30 €	15,40 € ▶



PERCUSSÃO E CORTE

MARTELOS DE FUNILEIRO

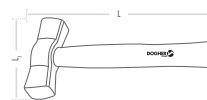
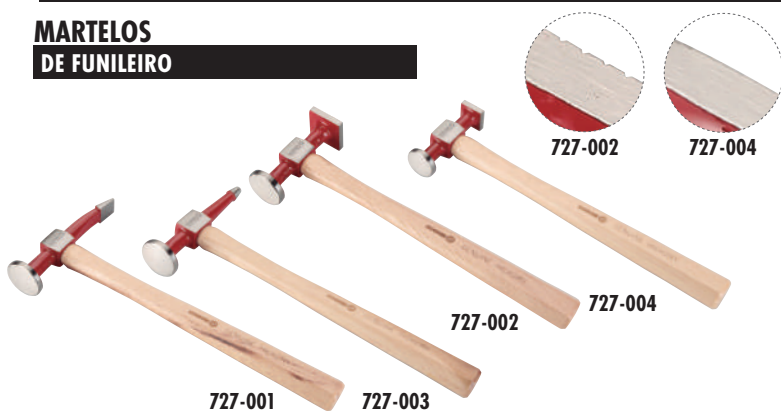

NOVIDADE

L1	L mm	Ø mm	∠ mm	gr.	Ref	Preço	Preço
▶ 142	325	40	-	400	727-001	58,68 €	34,51 €
130	325	40	38x38	450	727-002	57,05 €	33,56 €
138	325	40	-	400	727-003	53,15 €	31,26 €
90	325	30	26x26	340	727-004	56,95 €	33,50 € ▶

NOVIDADE

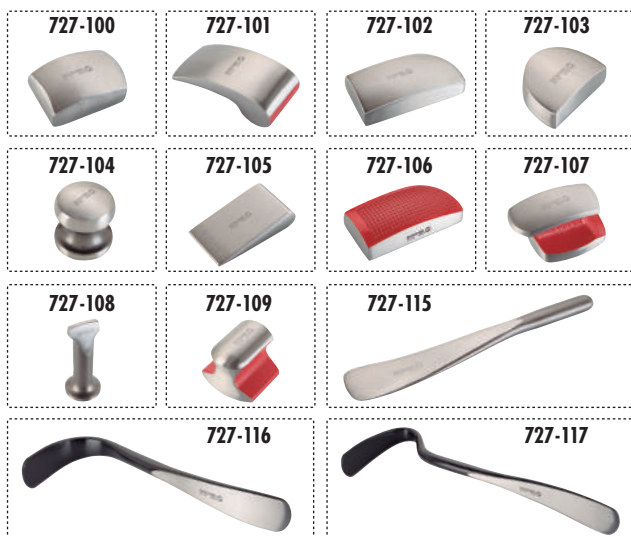

	L mm	Ref	Preço	Preço
▶ Tas Americano	83x63x32	727-100	68,50 €	40,29 €
Tas de Coma	132x58x45	727-101	71,16 €	41,85 €
Tas Americano Ligero	120x58x29	727-102	79,36 €	46,68 €
Tas de Tacón	79x60x30	727-103	63,64 €	37,44 €
Tas Diavolo Convexo	56x58	727-104	53,90 €	31,71 €
Tas de Cuña	112x64	727-105	53,27 €	31,34 €
Tas Curvas Cuadrículado	120x58x29	727-106	71,01 €	41,76 €
Tas Forma de Yunque	102x72x62	727-107	83,36 €	49,03 €
Tas Redondo	125x54x44	727-108	63,64 €	37,44 €
Tas Universal	61x70x69	727-109	72,55 €	42,68 €
Palanca Cuchara	390	727-115	122,22 €	71,90 €
Palanca Desabollar	401x59	727-116	133,02 €	78,25 €
Palanca Desabollar Doble Curva	480x60	727-117	139,14 €	81,85 €

CABECA DE MARTELO DE BORRACHA SDS PLUS



▶ Ref 730-001
~~24,36 €~~ **14,32 €**
95 x 36,8 mm

NOVIDADE

TALHADEIRA DE FUNILEIRO



▶ Ref 757-26-07-240
~~20,36 €~~ **11,97 €**
26 x 7 x 240 mm

NOVIDADE

MACHADO PUNHO HICKORY



g	L mm	Ref	Preço	Preço
▶ 500	450	724-500	26,89 €	15,82 €
700	445	724-700	29,10 €	17,12 €
1000	675	724-1000	39,62 €	23,31 €
NOVIDADE	1200	724-1200	46,36 €	27,26 €
NOVIDADE	1500	724-1500	55,36 €	32,56 €
NOVIDADE	2000	724-2000	63,25 €	37,21 € ▶

MACO CUNHA PUNHO FIBRA DE VIDRO

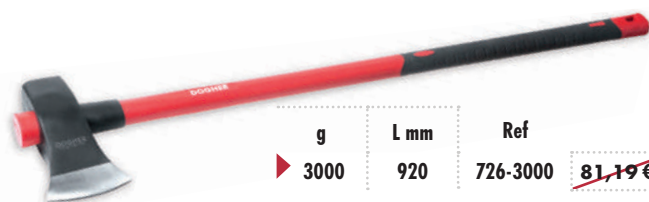

▶ g 3000 L mm 920 Ref 726-3000 ~~81,19 €~~ **47,75 €** ▶

CUNHAS

g	Ref	Preço	Preço
▶ 1000	726-010	28,23 €	16,60 €
1500	726-015	30,33 €	17,84 €
2000	726-020	35,03 €	20,60 €
3000	726-030	47,88 €	28,15 € ▶

**JOGO ABRE-FUROS EM AÇO
COM BOCAS INTERCAMBIÁVEIS**

11
Pcs



Ref 940-320
~~128,33 €~~ **75,49 €**

940-03-20 Ø 2-20 mm



940-103 Ø 3
940-104 Ø 4
940-106 Ø 6

940-108 Ø 8
940-110 Ø 10



940-112 Ø 12
940-114 Ø 14
940-116 Ø 16

940-118 Ø 18
940-120 Ø 20



**JOGO ABRE-FUROS BIMATERIAL
COM BOCAS INTERCAMBIÁVEIS**

16
Pcs



Ref 940-330
~~257,25 €~~ **151,32 €**

940-03-30 Ø 2-30 mm



940-103 Ø 3
940-104 Ø 4
940-106 Ø 6

940-108 Ø 8
940-110 Ø 10



940-112 Ø 12
940-114 Ø 14
940-116 Ø 16
940-118 Ø 18
940-120 Ø 20

940-122 Ø 22
940-124 Ø 24
940-126 Ø 26
940-128 Ø 28
940-130 Ø 30



**SACA-TROÇOS
CILÍNDRICOS**

**ESTOJO DE SACA-TROCOS CILÍNDRICOS
CABO OCTOGONAL "TOPGRIP" PATENTEADO**

Ø 2 · 3 · 4 · 5 · 6 · 8 mm

Protetor TOPGRIP
Norma NFE 71211
DIN 6450C

Ref 7445-001

~~65,04 €~~ **38,25 €**



**CAIXA DE PLÁSTICO DE SACA-TROCOS CILÍNDRICOS
CABO OCTOGONAL**

6
Pcs

Ø 3 · 4 · 5 · 6 · 8 · 10 mm

Ref 7446-003

~~49,15 €~~ **28,91 €**



SACA-TROCOS

PUNHO "SHOCKGRIP" PATENTEADO

Saca-Troços desenhados para resistir grandes impactos. O seu desenho faz que a pancada se transmita através do interior do corpo, diminuindo eficazmente o efeito rebote. Graças ao punho patenteado SHOCKGRIP, o agarramento é mais ergonómico e evitam-se danos nas mãos.

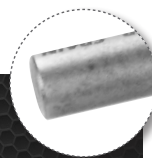

**ESTOJO DE SACA-TROCOS CILÍNDRICOS
CABO OCTOGONAL "SHOCKGRIP" PATENTEADO**

5

Pcs

Ø 3 · 4 · 5 · 6 · 8 mm

Ref 7447-001

~~86,18 €~~ **51,87 €**



**ESTOJO DE SACA-TROCOS CILÍNDRICOS
CABO "SHOCKGRIP" PATENTEADO SÉRIE LONGA**

4

Pcs

Ø 10 · 12 · 14 · 16 mm

Ref 7447L-001

~~144,28 €~~ **84,88 €**



**PUNÇÃO
AUTOMÁTICO**

Cr-V 143 mm 36 kgs



Ref 750-013

~~38,45 €~~ **22,62 €**

• Potência Máxima 36 kgs.

**AGULHA DE TRACAR
SEXTAVADA GALVANIZADA**



Ref 796-003

~~6,87 €~~ **4,04 €**

• Ponta de Carboneto de Tungstênio



ARCO DE SERRA STD



L mm	Ref	18,23 €	10,72 €
300	840-004		

Inclui Folha Bi-metal
Permite a instalação de folhas de 25 mm de largura
45° - 90° · Amarração da Folha

ARCO DE SERRA PROFISSIONAL

- Inclui Folha Bi-metal
- Punho de Alumínio
- Armazem para 10 Folhas
- 45° - 90° · Amarração da Folha



L mm	Ref	42,15 €	24,79 €
300	840-002		

FOLHAS DE SERRA DE MÃO BIMETÁLICAS

BI



840-050



840-059

L mm	A mm	B mm	Z		Ref	240,79 €	141,65 €
300	13	0,65	24	100	840-050		
300	13	0,65	24	100	840-059	356,03 €	209,43 €

TESOURA CORTACHAPA CORTE RETO

NOVIDADE

CrV 250 mm

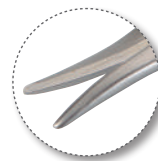

XTREME



Ref	34,32 €	20,19 €
285-025		

JOGO DE 2 FOLHAS DE SERRA DE MÃO DE DUPLO CORTE

BI 24 Z

CV



Ref	2,83 €	1,66 €
840-070		

JOGO DE 2 FOLHAS DE SERRA DE MÃO BIMETÁLICAS

BI 24 Z

HSS



Ref	6,02 €	3,51 €
840-067		

SERRA PROFISIONAL PARA PODA



- Ponta afiada para corte frontal.
- Adequada para gesso cartonado.

L mm	Ref	18,78 €	11,04 €
150	842-001		

SERRA ABATÍVEL PUNHO BIMATERIAL



QUICK

L mm	Ref	26,88 €	15,81 €
190	843-001		

- Pladur e madeira

X-ATO
ULTRA RESISTENTE

CUT PRO SK2 BLACK Diamond



- Proteção de lâmina longa
- Punho ergonómico antiderrapante con foro anticaduta.

A mm	L mm	Ref	Price
25	215	850-250	17,12 € 10,07 €

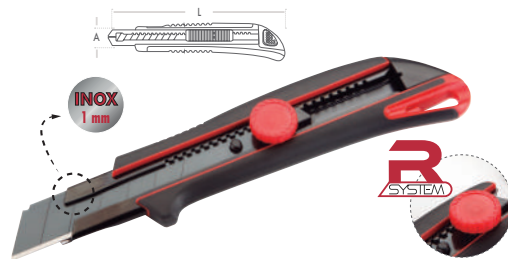

X-ATO
DE SEGURANÇA MULTIFUNÇÃO

CUT PRO SK2 BLACK Diamond

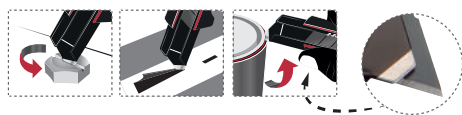
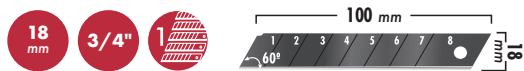

- Proteção de lâmina extra longa.
- Punho ergonómico antiderrapante con foro anticaduta.
- Depósito de 2 lâminas de substituição.

A mm	L mm	Ref	Price
18	190	850-181	14,98 € 8,76 €



X-ATO
MULTIFUNÇÃO

CUT PRO SK2 BLACK Diamond



- Aço inoxidável na ponta. Máxima durabilidade.
- Dupla guia de fixação da lâmina.
- Punho ergonómico, bimatérial, soft touch e alumínio.
- Furo anti-queda.

A mm	L mm	Ref	Price
18	160	850-180	15,71 € 9,19 €



X-ATO SIMPLES
COM PARAFUSO DE BLOQUEIO

CUT PRO HARD Blades

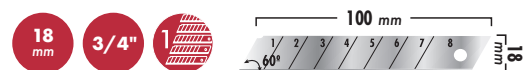

- Depósito de lâmina de substituição.

A mm	L mm	Ref	Price
18	160	789-001	5,68 € 3,34 €



SACO INDIVIDUAL DE NYLON
PARA X-ATO



A mm	Ref	Price
18	789V-18	11,73 € 6,87 €

MINI CUTTER
SECURITY SYSTEM



A mm	Ref	Price
9	850-003	3,12 € 1,84 €

X-ATO
DE SEGURANÇA



CUT PRO SK2 Long Life



- Sistema de segurança com lâmina auto retrátil.
- Aço inoxidável na ponta. Máxima durabilidade.
- Punho soft touch, antiderrapante e furo anti-queda.

A mm	L mm			Ref	
19	155	1	0,6	850-005	11,63 € 6,81 €



X-ATO
P SYSTEM



CUT PRO SK2 BLACK Diamond

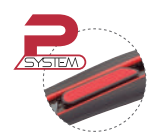

- Punho ergonómico antiderrapante con foro anticaduta.
- Proteção de lâmina extra longa.

A mm	L mm			Ref	
9	153	1	0,4	850-091	7,72 € 4,51 €

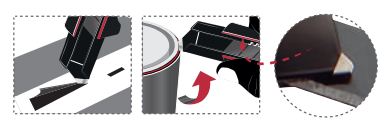

RASPADOR



CUT PRO SK2 Long Life



- Guarda de lâmina.
- Punho ergonómico antiderrapante.

A mm	L mm			Ref	
17,5	380	1	0,36	887-010	41,95 € 24,56 €



RASPADOR
PROFISSIONAL

- Lâmina de carboneto
- Ponto giratório 360
- Remove facilmente tintas, colas, vernizes ou óxidos.
- Ponto de apoio giratório 360º para manobrar em diferentes ângulos.
- Cabo bi-material ergonómico e antiderrapante.



C mm	Ref	
60 mm	887-001	31,01 € 18,24 €



ESPÁTULA CABO BIMATERIAL
FOLHA RÍGIDA

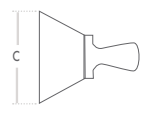

Inox



C mm	Ref	
152	881-PH2	21,12 € 12,43 €

ESPÁTULA
CABO BIMATERIAL

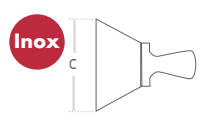

Inox



C mm	Ref	
30	879-30	6,11 € 3,59 €
40	879-40	6,16 € 3,62 €
50	879-50	6,46 € 3,79 €
60	879-60	6,75 € 3,97 €
70	879-70	7,22 € 4,24 €
80	879-80	7,74 € 4,56 €
100	879-100	8,64 € 5,09 €
120	879-120	9,93 € 5,84 €
150	879-150	11,91 € 7,00 €

**COLHER DE PEDREIRO TIPO NORTE
FORJADA CABO MADEIRA**



	C mm	L mm	Ref	
▶ A	115	180	893-01-180	26,51 € 15,59 € ▶



**COLHER DE PEDREIRO TIPO NORTE
CABO BIMATERIAL**



	C mm	L mm	Ref	
▶ A	115	180	883-02-180	15,73 € 9,25 € ▶

**COLHER DE PEDREIRO TIPO MADRID
FORJADA CABO MADEIRA**



	C mm	L mm	Ref	
▶ F-H	98	190	893-03-190	25,27 € 14,87 € ▶



**COLHER DE PEDREIRO TIPO MADRID
CABO BIMATERIAL**

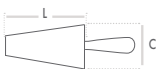

	C mm	L mm	Ref	
▶ F-H	98	178	883-04-180	14,31 € 8,41 € ▶

**COLHER DE PEDREIRO TIPO CATALÁN
FORJADA CABO MADEIRA**



	C mm	L mm	Ref	
▶ B	120	180	893-05-180	28,11 € 16,53 € ▶



**COLHER DE PEDREIRO TIPO CATALÁN
CABO BIMATERIAL**

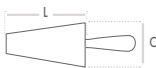

	C mm	L mm	Ref	
▶ B	120	170	883-06-170	15,08 € 8,87 € ▶

**TIRA-LINHAS COM DEPÓSITO
PARA PÓ TRAÇADOR**



	m	Ref	
▶	30	798-001	12,79 € 7,53 € ▶



**DESEMPENADEIRA RETANGULAR
CABO MADEIRA**

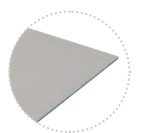

	C mm	L mm	Ref	
▶ 01	150	300	886-002	15,31 € 9,00 € ▶

**DESEMPENADEIRA RETANGULAR
CABO BIMATERIAL**

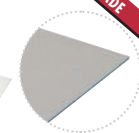

	C mm	L mm	Ref	
▶ 01	150	300	886-102	19,11 € 11,24 € ▶



**DENTADA
CABO BIMATERIAL**



	C mm	L mm	Ref	
▶ 06	120	280	886-105	17,02 € 10,01 € ▶

**DENTADA
CABO BIMATERIAL**



	C mm	L mm	Ref	
▶ 06	120	280	886-106	17,02 € 10,01 € ▶



**DENTADA
CABO BIMATERIAL**



	C mm	L mm	Ref	
▶ 06	120	280	886-107	17,02 € 10,01 € ▶

**DENTADA
CABO BIMATERIAL**



	C mm	L mm	Ref	
▶ 06	120	280	886-120	17,02 € 10,01 € ▶



DESEMPENADEIRA DE ESPONJA BAIXA DENSIDADE

C mm	L mm	Ref	
▶ 140	280	886-018	13,68 € 8,04 € ▶



- Esponja de baixa densidade
- Base com 30mm de espessura

DESEMPENADEIRA DE BORRACHA-ESPONJA

- Base com 20 mm de espessura
- Cabo e base fabricados em poliuretano
- Buracos na esponja de maior diâmetro do que a 886-017

C mm	L mm	Ref	
▶ 140	280	886-016	17,06 € 10,03 € ▶



DESEMPENADEIRA DE BORRACHA-ESPONJA DENSA

- Base com 20 mm de espessura
- Cabo e base fabricados em poliuretano
- Buracos na esponja de menor diâmetro do que a 886-016

C mm	L mm	Ref	
▶ 140	280	886-017	17,45 € 10,26 € ▶



RASPadeira RECTANGULAR

g	A mm	B mm	Ref	
▶ 1400	310	130	876-010	25,64 € 15,09 € ▶



RASPadeira SEMI-CIRCULAR

g	A mm	B mm	Ref	
▶ 1200	270	160	876-020	22,84 € 13,44 € ▶



RASTELO

Nº	g	A mm	B mm	Ref	
▶ 12	575	350	95	874-012	13,32 € 7,79 €
14	670	410	95	874-014	14,06 € 8,24 €
16	776	475	95	874-016	14,82 € 8,68 €
▶ 18	890	530	95	874-018	16,48 € 9,69 € ▶

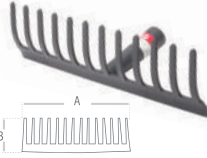

CABO RETO PARA RASTELO

L mm	Ref	
▶ 1200	874-001	11,66 € 6,82 € ▶



BARRA PARA DESMOLDAR



L mm	mm	Ref	
▶ 300	14	884-04-300	14,59 € 8,57 €
500	20	884-05-500	21,57 € 12,69 €
600	20	884-05-600	27,73 € 16,31 €
700	20	884-05-700	31,52 € 18,54 €
800	22	884-05-800	34,98 € 20,57 €
900	22	884-05-900	40,82 € 24,00 €
1000	22	884-05-1000	45,17 € 26,56 €
1200	22	884-05-1200	50,92 € 29,96 € ▶

CORTA-CABOS PROFISSIONAL



L mm	mm	Ref	
▶ 200	0,5~2	292-200	45,35 € 26,01 €
300	1~3,5	292-300	62,29 € 35,72 €
320	2~6,5	292-320	72,44 € 41,54 €
470	4~8	292-470	96,65 € 55,43 €
630	5~11	292-630	121,22 € 69,53 €
750	6~13	292-750	165,50 € 94,91 €
900	8~17	292-900	225,84 € 129,51 €
1050	9~19	292-1050	281,89 € 161,68 € ▶

ALICATE DIAGONAL ARTICULADO



Capacidade de corte	Ref	
▶ Cabo plano	3,8 mm	Ref 207-225
Cabo brando	6 mm	50,99 € 29,99 €

PÁS

CABO DE MADEIRA



PÁ PONTA COM CABO MULETA



g	A mm	B mm	L mm	Ref	
2000	340	280	1020	870-010	29,83 € 17,54 €

PÁ QUADRADA COM CABO MULETA



g	A mm	B mm	L mm	Ref	
2000	340	280	1020	870-020	29,83 € 17,54 €

PÁ PONTA COM CABO "Y"



g	A mm	B mm	L mm	Ref	
2000	340	280	1020	870-030	33,49 € 19,69 €

PÁ QUADRADA COM CABO "Y"



g	A mm	B mm	L mm	Ref	
2000	340	280	1020	870-040	34,09 € 20,04 €

PÁS DE ALUMÍNIO COM CABO "Y"



PÁ DE ALUMÍNIO COM CABO "Y"



g	A mm	B mm	L mm	Ref	
1500	390	315	1130	871-010	50,35 € 29,62 €

PÁ DE ALUMÍNIO COM CABO "Y"



g	A mm	B mm	L mm	Ref	
1000	305	245	1020	871-030	37,54 € 22,07 €

PÁ DE PLÁSTICO COM CABO "Y"



g	A mm	B mm	L mm	Ref	
1600	460	360	1250	871-050	44,34 € 26,07 €

PÁ QUADRADA COM CABO "Y"



g	A mm	B mm	L mm	Ref	
1800	295	225	1010	870-041	35,23 € 20,72 €

PISTOLAS, APLICADOR, ROQUETE

PISTOLA DE ESPUMA POLIURETANO PRO



L mm	L2 mm	Ø mm	Ø2 mm	Ref	
▶ 325	190	11	14	914-001	41,63 € 24,49 € ▶

PISTOLA DE MÁSTIQUE



L mm	Ø mm	Ref	
▶ 225	55	917-225	37,13 € 21,74 € ▶

• Para cartuchos de 310 ml e coaxial de 150 ml

PISTOLA DE MÁSTIQUE COM CORTE



L mm	Ø mm	Ref	
▶ 225	57	915-225	24,53 € 14,43 € ▶

• Para cartuchos de 310 ml e coaxial de 150 ml

PISTOLA DE MÁSTIQUE PUNHO DE ALUMÍNIO



L mm	Ø mm	Ref	
▶ 225	55	912-225	21,89 € 12,88 € ▶

• Para cartuchos de 310 ml e coaxial de 150 ml

ROQUETE PARA ANDAIMES



A mm	B mm	L mm	Ref	
▶ 19	22	320	892-19-22	48,55 € 28,54 € ▶

PISTOLA DE MÁSTIQUE



L mm	Ø mm	Ref	
▶ 225	55	918-225	35,11 € 20,65 € ▶

- Para cartuchos de 310 ml e coaxial de 150 ml
- Multiplicador de força.
- Seletor antigotejamento.

PISTOLA DE MÁSTIQUE DE RETROCESSO RÁPIDO



L mm	Ø mm	Ref	
▶ 225	55	916-225	22,28 € 13,10 € ▶

• Para cartuchos de 310 ml e coaxial de 150 ml

PISTOLA DE MÁSTIQUE PISTÃO TRIPLO



L mm	Ø mm	Ref	
▶ 225	78	914-225	35,03 € 20,60 € ▶

• Para cartuchos de 380 ml, 410 ml e 500 ml. Pistola para chumbador químico.

APLICADOR DE ARGAMASSA ESTRUTURA DE ALUMÍNIO



L mm	Ø mm	Ref	
▶ 375	50	913-375	29,58 € 17,40 € ▶

SUPORTE PARA CHAVE DE ANDAIMES

- Couro de alta qualidade.
- Rebites de alta resistência.

▶	Ref 075-008	
12,73 €	7,49 €	▶



GRAMPO DE ÊMBOLO

900 Kg



L mm	Ref	Price	Price
150	855-30-150	28,03 €	16,49 €
200	855-30-200	30,17 €	17,75 €
250	855-30-250	32,39 €	19,05 €
300	855-30-300	34,35 €	20,21 €
400	855-30-400	37,70 €	22,18 €
600	855-30-600	44,24 €	26,02 €

30x8 Jante

L mm	Ref	Price	Price
200	855-35-200	34,93 €	20,55 €
300	855-35-300	38,61 €	22,71 €
400	855-35-400	42,01 €	24,71 €
500	855-35-500	45,54 €	26,79 €
600	855-35-600	48,84 €	28,73 €
800	855-35-800	56,39 €	33,17 €
1000	855-35-1000	63,74 €	37,49 €
1200	855-35-1200	71,06 €	41,80 €
1500	855-35-1500	81,18 €	47,75 €
2000	855-35-2000	96,97 €	57,04 €

35x8 Jante



SUPORTE DE EXPANSÃO

300 Kg



	L max.		L min.		Ref	Price	Price
	mm	kg max	mm	kg max			
NOVIDADE	1000	300	600	300	855-60-100	51,85 €	30,50 €
	1700	200	950	300	855-95-170	58,35 €	34,32 €
	2900	100	1550	300	855-155-290	63,42 €	37,31 €
NOVIDADE	3750	46	2000	300	855-200-375	72,16 €	42,45 €



JOELHEIRA DESLIZANTE COM 5 RODAS



Ref 075-028
~~94,00 €~~ 55,29 €

525 x 255 x 90 mm

GRAMPO AUTOMÁTICO REVERSÍVEL LEVE

16x5 Jante

120 Kg



L mm	Ref	Price	Price
150	855-150	24,77 €	14,57 €
300	855-300	27,26 €	16,03 €
450	855-450	29,68 €	17,46 €
600	855-600	39,15 €	23,03 €



VENTOSAS

Ø mm	kg	Ref	Price	Price
115	50 kg	945-001	19,41 €	11,41 €



Ø mm	kg	Ref	Price	Price
115	100 kg	945-002	38,82 €	22,84 €



Ø mm	kg	Ref	Price	Price
115	130 kg	945-003	53,70 €	31,59 €



Ø mm	kg	Ref	Price	Price
203	180 kg	945-004	102,25 €	60,15 €



VENTOSAS PARA VIDROS DE CARROS

Ø mm	kg	Ref	Price	Price
118	80 kg	945-005	46,60 €	27,41 €



Ø mm	kg	Ref	Price	Price
230	200 kg	945-006	176,94 €	104,07 €



TESOURAS

DE PODA

TESOURA DE PODA HEAVY DUTY



- Lâmina superior e inferior CK67 de alta resistência com revestimento de **Ilaflon**
- Cabo de alumínio e revestimento de PVC.
- Fecho de segurança.



	L mm	Ref	
▶ 15	210	960-003	27,65 € 16,26 € ▶

LIMAS

JOGO DE 3 LIMAS PUNHO BIMATERIAL

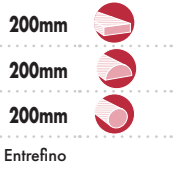

	Ref 815-001
▶ 37,66 €	22,15 €



Inclui Capa de Nylon

LIMA CHATA

GRÃO ENTREFINO PUNHO BIMATERIAL

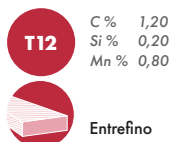

L"	L mm	Ref	
▶ 6	150	803-150	8,31 € 4,88 €
8	200	803-200	10,68 € 6,28 €
10	250	803-250	12,79 € 7,53 €
12	300	803-300	16,07 € 9,46 € ▶

LIMA CHATA

GRÃO BASTO PUNHO BIMATERIAL

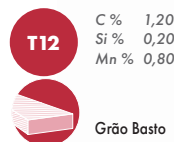

L"	L mm	Ref	
▶ 6	150	803B-150	7,90 € 4,65 €
8	200	803B-200	9,68 € 5,69 €
10	250	803B-250	12,15 € 7,13 €
12	300	803B-300	15,27 € 8,99 € ▶

JOGO DE 6 LIMAS DE AGULHA



▶ L160 mm	Ref 817-001
27,50 €	16,18 €

JOGO DE 12 LIMAS DE AGULHA

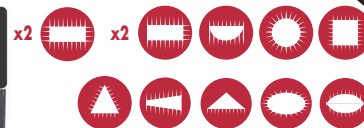

▶ L160 mm	Ref 817-002
52,22 €	30,72 €

JOGO DE 10 LIMAS DIAMANTADAS 140 mm

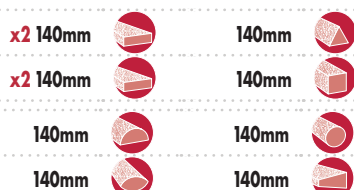

▶	Ref 816-001
138,98 €	81,75 €

LIMA

PARA A REPARAÇÃO DE ROSCAS

- Para roscas externas e internas
- Passos métricos: 0,80-1,00-1,25-1,50-1,75-2,00-2,50-3,00



	Ref 817-010
71,27 €	41,93 €

ALICATES DE REBITAR

ALICATE DE REBITAR ARTICULADO MANUAL MULTI-FUNÇÃO



PISTOLA PARA FIXAÇÃO DE ÂNCORAS METÁLICAS

• Adequado para métricas: M3-M4-M5-M6-M8

Ref 919-030
~~39,36 €~~ 23,15 €



x10 Pcs: M5 x 52 mm
 x10 Pcs: M5 x 37 mm
 x10 Pcs: M4 x 32 mm



ALICATE DE REBITAR PROFISSIONAL



Ref 918-010
~~41,78 €~~ 24,57 €

- Cabeça com bicos intermutáveis
- Inclui 4 bicos Ø 2,4-3,2-4-4,8 mm.
- Incorpora a mola extratora do rebite
- Punho ergonómico antiderrapante



ALICATE DE REBITAR DE DUAS MÃOS COM BICO MULTIMEDIDA

- Garras de Metal Duro
- Multiplicador de Força Interna
- Punhos ergonómicos
- Corpo de alumínio
- Para rebites Ø 2,4-3,2-4-4,8-6,4 mm
- Rebites Inoxidáveis: Ø 2,4-3,2-4-4,8 mm

Ref 919-016
~~77,09 €~~ 45,35 €



ALICATE DE REBITAR MANUAL MULTI-FUNÇÃO



Ref 919-020
~~148,76 €~~ 87,50 €

ALICATE DE REBITAR PARA PORCAS

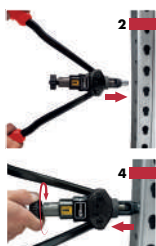

- Este alicate de rebitar é especial para trabalhos intensivos.
- Alicates de rebitar ergonómico para reduzir o esforço.
- Substituição fácil de componentes.
- Inclui chave multi-função + 7 bicos

410 mm Ref 919-025
~~124,20 €~~ 73,06 €



EXTRATOR MÚLTIPLO DE 2 E 3 PERNAS

- 100 mm Cr-V
- 200 mm
- 250 mm

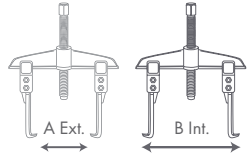

L mm	A min-A max	B min-B max	Ref
▶ 100-250	30-140	55-170	905-004 458,81 € 269,88 € ▶

JOGO DE SEPARADORES

- Cr-V
- 30-50 mm
- 50-75 mm

min-max	Ref
▶ 30-75	905-005 266,29 € 156,63 € ▶



CHAVE DE FILTRO COM FITA METÁLICA



mm	Ref
▶ 65~105	481-65-105 26,66 € 15,68 €
110~165	481-110-165 28,32 € 16,66 € ▶

• Para a mudança da Fita soltar o parafuso da base giratoria.

CHAVE FLEXÍVEL DE FILTRO COM CORRENTE



L mm (Corrente)	Ø mm	Ref
▶ 350	60-105	481-010 56,95 € 33,49 €
520	60-160	481-011 84,71 € 49,82 € ▶

CHAVE DE FILTRO DE CORREIA



L mm (Correia)	Ø mm	Ref
▶ 580	60-140	481-020 36,30 € 21,34 €
840	60-265	481-021 67,29 € 39,59 € ▶

11 PEÇAS

JOGO DE FERRAMENTAS PARA INTERIORES



- Ferramentas para facilitar a remoção de painéis, tabliers, molduras e outros acessórios do interior de automóveis.
- Feitas de plástico de alta resistência para uma longa durabilidade.
- Eles evitam possíveis danos às superfícies e peças mais macias.



▶	Ref 480-011
42,26 €	24,74 €

ALICATE PARA BRACADEIRAS ELÁSTICAS DE AUTO-APERTO



600 mm



- Comprimento do cabo 600 mm
- Para braçadeiras de difícil instalação, fornecido com um gatilho de retenção para deixar a braçadeira aberta para a sua fácil colocação ou extração.
- Permite um alcance adicional, a extração e o travamento das braçadeiras na posição aberta.
- Para braçadeiras em mangueiras de água, óleo ou combustível.
- Faixa de trabalho: 10-63 mm
- Sistema de bloqueio, liberação de mãos e facilitação do trabalho.

Ref 2200-005
~~109,75 €~~ **64,56 €**

ALICATE PARA TUBOS FLEXÍVEIS



L mm	Ref	9,97 €	5,85 €
▶ 155	2200-010	12,43 €	7,31 €
▶ 250	2200-012	16,97 €	9,97 €

- Para estrangular / bloquear tubos flexíveis.
- Aplicações: Linhas de combustível, aquecimento, sistema de refrigeração, radiadores, freios, etc ...
- Sistema de fácil ajustamento com uma mão.



ALICATE ISOLADO PARA TUBOS FLEXÍVEIS

DIN EN/IEC 60900

200 mm



TESTED

L mm	Ref	29,21 €	17,18 €
▶ 200	2201-200		



NOVIDADE

ALICATE EXTRA LONGO DE PONTAS PARA MANGUEIRA

CrV

L mm 280



Ø 13 mm

L mm	Ref	32,15 €	18,91 €
▶ 280	2200-292		



NOVIDADE

ESPELHO PARA INSPEÇÃO



Ref 930-001
~~16,17 €~~ **9,51 €**
 L min-max. 240-930 Ø 56,5 mm

APANHADOR MAGNÉTICO TELESCÓPICO

680 g



L mm	→	← mm	Ref	10,91 €	6,41 €
▶ 635		7	343-020		

MACACOS HIDRÁULICOS

MACACO HIDRÁULICO REBAIXADO



- Rodas giratórias traseiras para facilitar as manobras.



- O design de perfil baixo torna mais fácil alcançar os pontos de elevação na maioria dos veículos.



- Rodas dianteiras duplas.

Capacidade	Altura mín.	Altura máx.	N.W. kg.	Dimensões mm	Ref	CE
▶ 2 TON	80 mm	510 mm	43 kg	822x360x214	9010-02	787,27 € 463,10 € ▶



- Rodas giratórias traseiras para facilitar as manobras.



- Alavanca de liberação de segurança com travamento positivo giratório 360°.



- Assento giratório 360° para maior versatilidade.

Capacidade	Altura mín.	Altura máx.	N.W. kg.	Dimensões mm	Ref	TUV GS CE
▶ 2 TON	89 mm	359 mm	14,2 kg	556x234x140	9015-02	204,36 € 120,21 €

- Válvula de segurança interna.



MACACO HIDRÁULICO



- Rodas giratórias traseiras para facilitar as manobras.



- Assento giratório 360° para maior versatilidade.

Capacidade	Altura mín.	Altura máx.	N.W. kg.	Dimensões mm	Ref	CE
▶ 2 TON	135 mm	340 mm	8,7 kg	447x196x135	9025-02	144,80 € 85,18 €

Capacidade	Altura mín.	Altura máx.	N.W. kg.	Dimensões mm	Ref	CE
▶ 3 TON	135 mm	400 mm	16,7 kg	520x195x135	9025-03	215,39 € 126,69 €



- Rodas de aço de alta resistência.

MACACOS TIPO GARRAFA E HIDRÁULICOS

MACACO TIPO GARRAFA SOLDADO



• Válvula de escape.



• Assento serrilhado com tratamento térmico e com ajuste do parafuso para maior versatilidade.



• Ensamblagem para cabo.

HIDRA PRO

• Construído em aço de alta qualidade de acordo com os padrões de qualidade e durabilidade.

• A tinta é resistente ao óleo, a graxa e a sujeira para uma limpeza fácil.



• Alavanca telescópica

Capacidade	Altura mín.	Altura elevação	Altura ajustável	Altura máx.	N.W. kg.	Ref	TUV GS CE	
▶ 02 TON	168 mm	100 mm	48 mm	316 mm	2 kg	9000-02	55,90 €	32,88 €
05 TON	207 mm	127 mm	60 mm	404 mm	3,7 kg	9000-05	73,70 €	43,35 €
10 TON	222 mm	145 mm	80 mm	447 mm	4,7 kg	9000-10	95,83 €	56,37 € ▶

• Construído em aço de alta qualidade de acordo com os padrões de qualidade e durabilidade.

• A tinta é resistente ao óleo, a graxa e a sujeira para uma limpeza fácil.

• Cabo de aço para o fácil transporte do macaco



• Alavanca telescópica

Capacidade	Altura mín.	Altura elevação	Altura ajustável	Altura máx.	N.W. kg.	Ref	TUV GS CE	
▶ 15 TON	227 mm	150 mm	80 mm	457 mm	6,9 kg	9000-15	128,99 €	75,87 €
20 TON	225 mm	150 mm	60 mm	445 mm	8,8 kg	9000-20	160,69 €	94,51 €
32 TON	260 mm	160 mm	-	420 mm	17,8 kg	9000-32	243,56 €	143,28 € ▶

GRUA HIDRÁULICA DOBRÁVEL

- Este produto foi especialmente projetado para elevar, baixar e transportar motores, diferenciais, transmissões e outras cargas pesadas com o mínimo esforço.
- Este produto foi testado quanto à confiabilidade e segurança.
- Estrutura inferior com rodas para maior estabilidade e facilidade de rotação.
- Braço de elevação ajustável.
- Construção em aço tubular de calibre pesado.
- Dobra-se ao meio para um fácil armazenamento.



• 2 rodas giratórias



• 4 rodas giratórias

Capacidade	Altura mín.A	Altura máx.B	Comprimento máx.C	Largura máx.D	N.W. kg.	Ref	TUV GS CE	
▶ 1 TON	25 mm	2.040 mm	1.510 mm	1.015 mm	65 kg	9030-01	661,89 €	389,35 € ▶

Capacidade	Altura mín.A	Altura máx.B	Comprimento máx.C	Largura máx.D	N.W. kg.	Ref	TUV GS CE	
▶ 2 TON	25 mm	2.445 mm	1.740 mm	1.040 mm	110 kg	9030-02	1.233,62 €	725,68 € ▶

MACACOS

DE FOSSAS

- Para trabalhos em fossas ou sob veículos elevados.
- A subida e descida a pedal permite manter as mãos livres.
- Fácil manipulação graças às suas quatro rodas giratórias e à grande estabilidade da base.



• Válvula.



• A ampla base oferece grande estabilidade.



• 4 rodas giratórias 360° de aço de alta resistência facilitam a mobilidade.

Capacidade	Altura mín.	Altura máx.	N.W. kg.	Ref	CE	
▶ 0,5 TON	1.140 mm	1.945 mm	24 kg	9040-0,5	490,41 €	288,47 €



• Válvula



• A subida e descida a pedal permite manter as mãos livres.



• A ampla base oferece grande estabilidade.



• 4 rodas giratórias 360° de PA de alta resistência facilitam a mobilidade.

Capacidade	Altura mín.	Altura máx.	N.W. kg.	Ref	CE	
▶ 1,5 TON	1.130 mm	1.915 mm	24 kg	9040-1,5	1.019,14 €	599,50 €



- Construído em aço de alta qualidade e grande resistência.

- A tinta é resistente ao óleo, a graxa e a sujeira.

- O acabamento de tinta sem chumbo é aplicado após uma lavagem química completa para garantir um acabamento duradouro e ajudar a prevenir a ferrugem.



- Construído em aço de alta qualidade e grande resistência.

- A tinta é resistente ao óleo, a graxa e a sujeira.

- O acabamento de tinta sem chumbo é aplicado após uma lavagem química completa para garantir um acabamento duradouro e ajudar a prevenir a ferrugem.

PREGUIÇAS

COM CREMALHEIRA

- Para trabalhos em fossas ou sob veículos elevados.
- A subida e descida a pedal permite manter as mãos livres.
- Fácil manipulação graças às suas quatro rodas giratórias e à grande estabilidade da base.



• A grande área grande da zona de apoio proporciona melhor contato com a carga.



• Dentado de travamento automático em ângulo invertido para a máxima segurança.



• Sistema de travamento duplo patenteado com pino triangular.

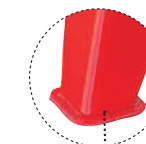

• O grande tamanho da base evita que afundem no asfalto e superfícies semelhantes.

- Construído em aço fundido de alta resistência.

- A tinta é resistente ao óleo, a graxa e a sujeira

- Aço soldado de alta resistência.



Capacidade	Altura mín.	Altura máx.	N.W. kg.	Ref	TUV GS		€/2u.
▶ 2 TON	278 mm	428 mm	5 kg	9050-02	71,40 €	42,00 €	
▶ 3 TON	288 mm	428 mm	6,6 kg	9050-03	75,60 €	44,47 €	
▶ 6 TON	395 mm	613 mm	12,9 kg	9050-06	166,21 €	97,76 €	

Capacidade	Altura mín.	Altura máx.	N.W. kg.	Ref	CE	
▶ 10 TON	468 mm	718 mm	27,8 kg	9050-10	277,50 €	163,24 €



Gavetas com função bloqueio / desbloqueio e fecho rápido



Fechadura centralizada de segurança



Rodas de alta resistência e travões de segurança



Protecção de plástico reforçado nas cantoneiras



10 x 10 mm
38 x 38 mm Painéis laterais furados



Carga máxima das gavetas: 40 - 45 Kg

**CARRO
7 GAVETAS**



Monza

Ref 025-014
~~1.318,85 €~~ **775,81 €**

**CARRO
6 GAVETAS**



Silverstone

Ref 025-015
~~1.277,23 €~~ **751,31 €**

**CARRO
5 GAVETAS**



Suzuka

Ref 025-016
~~1.198,97 €~~ **705,28 €**

Dimensões gama F1

Carro: 678 x 459 x 1.000 mm

Gavetas: 568 x 398 x 75 mm · 568 x 398 x 154 mm

**CARRO
7 GAVETAS**



Jerez

Ref 025-017
~~1.194,65 €~~ **702,74 €**

**CARRO
6 GAVETAS**



Sepang

Ref 025-019
~~1.149,80 €~~ **676,34 €**

Dimensões gama GP

Carro: 678 x 459 x 1.000 mm

Gavetas: 568 x 398 x 75 mm · 568 x 398 x 154 mm



Gavetas com função fecho rápido



Fechadura centralizada de segurança



Rodas de alta resistência e travões de segurança



Protecção de plástico reforçado nas cantoneiras inferiores

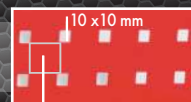

38 x 38 mm Painéis laterais furados



Carga máxima das gavetas: 30 - 35 Kg

std

Dimensões gama STD

Carro: 678 x 459 x 1.000 mm

Gavetas: 568 x 398 x 75 mm • 568 x 398 x 154 mm



Alça lateral de metal para fácil transporte



Fechadura centralizada de segurança



Rodas de alta resistência e travões de segurança



Carga máxima das gavetas: 30 - 35 Kg
Carga Total: 320 Kg

Características dos Carros

std

CARRO 7 GAVETAS



Ref 025-005

~~1.038,36 €~~ 610,79 €

CARRO 6 GAVETAS



Ref 025-006

~~930,63 €~~ 547,43 €

CARRO 5 GAVETAS



Ref 025-007

~~827,53 €~~ 486,78 €

CARRO 3 GAVETAS



680 x 458 x 995 mm

Ref 025-008

~~909,07 €~~ 534,76 €

CARRO METÁLICO 6 GAVETAS SF SYSTEM



Sistema Anti-tombamento



Ref 025-206

~~957,86 €~~ 560,63 €



SYSTEM
by DOGHER TOOLS



SAFETY SYSTEM

• Sistema de segurança anti-tombamento que permite apenas a abertura de uma gaveta de cada vez.

COMPOSIÇÃO +211 FERRAMENTAS

CARRO +211 FERRAMENTAS



Ref 025-015

Ref 025-563

~~2.338,51 €~~ 1.375,60€



CARRO +211 FERRAMENTAS



Ref 025-019

Ref 025-560

~~2.211,08 €~~ 1.300,63 €



CARRO +211 FERRAMENTAS

std

Ref 025-006

Ref 025-569

~~1.991,90 €~~ 1.171,71 €



205-080 • 330-080 • 451-080 • 450-080



Bandeja combinável 1/4

(375 x 140 x 30 mm) Conteúdo:

- ▶ Ref 205-080: 4 Alicates Profissionais
- ▶ Ref 330-080: 5 Chaves de Parafusos prof.
- ▶ Ref 451-080: 8 Chaves boca/luneta
- ▶ Ref 450-080: 8 Chaves de Bocas

840-080



Bandeja combinável 1

(375 x 560 x 30 mm) Conteúdo:

- ▶ Ref 840-080: Multi-ferramenta

500-084

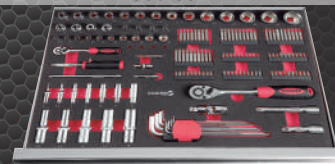

Bandeja combinável 1

(375 x 560 x 30 mm) Conteúdo:

- ▶ Ref 500-084: Multi-ferramenta

CARRO METÁLICO
3 BANDEJAS



Ref 025-028
~~301,25 €~~ 177,21 €

CARRO METÁLICO
3 BANDEJAS E 1 GAVETA

· inclui uma gaveta



Ref 025-029
~~369,85 €~~ 217,56 €

INOX

CARRO METÁLICO
COM 5 E 7 GAVETAS



Aisi 304

460 mm
846 mm
680 mm



Ref 20025-007

~~2.109,69 €~~ 1.520,22€

· Dim. Gaveta
568 x 398 mm

500 mm
998 mm
760 mm



Ref 20025-005

~~2.442,26 €~~ 1.759,87€

· Dim. Gaveta
644 x 399 mm

CONJUNTOS DE FERRAMENTAS
PARA OS CARROS DE OFICINA



MARCAGEM DESCRITIVO PARA UMA RÁPIDA PROCURA
ESPUMA DE ALTA DENSIDADE PARA A FÁCIL ADAPTAÇÃO DA FERRAMENTA

238 FERRAMENTAS
CONJUNTO DE 6 GAVETAS

Ref 025-504
~~3.253,91 €~~ 1.866,22 €

* Carro não incluído

▶ GAVETA 1

220X-080 • 205-080 • 225-080 • 276-080

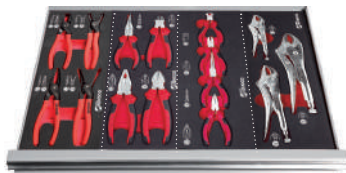

▶ GAVETA 2

300-081 • 330-081 • 351-081 • 360-080



▶ GAVETA 3

450-080 • 451-080 • 460-080 • 491-080

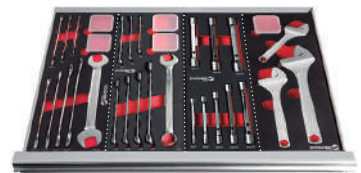

▶ GAVETA 4

840-080



▶ GAVETA 5

501-080 • 618-080



▶ GAVETA 6

534-080 • 538-080 • 502-080 • 503-080



* Consulte o conteúdo das bandejas combináveis Dogher tools nas páginas 57 até 63.

4 ALICATES

ALTA POTÊNCIA



160 mm



200 mm



180 mm



160 mm



Ref 200-080

~~154,28 €~~ **90,76 €**



1

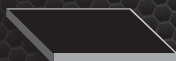

Dimensões 1:
375 x 560 x 30 mm

1/2



Dimensões 1/2:
375 x 280 x 30 mm

1/3



Dimensões 1/3:
375 x 188 x 30 mm

1/4



Dimensões 1/4:
375 x 140 x 30 mm

BANDEJAS COMBINÁVEIS
PARA OS CARROS DE OFICINA

DOGHER
TOOLS

4 ALICATES

PROFISSIONAIS



160 mm



160 mm



180 mm



180 mm



Ref 205-080

~~99,29 €~~ **58,40 €**



4 ALICATES

CIRCLIP®

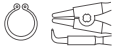

180 mm



180 mm

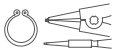

180 mm

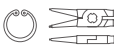

180 mm



Ref 220-080

~~79,53 €~~ **46,78 €**



4 ALICATES

CIRCLIP® PRO

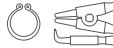

180 mm



180 mm

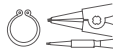

180 mm

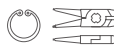

180 mm



Ref 220X-080

~~125,24 €~~ **73,66 €**



3 ALICATES

ISOLADOS 1000V



160 mm



180 mm



160 mm



Ref 250-080

~~126,71 €~~ **74,53 €**



4 MINI-ALICATES

PROFISSIONAIS

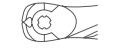

125 mm



125 mm

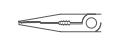

125 mm

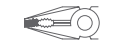

125 mm



Ref 225-080

~~78,65 €~~ **46,26 €**



4 MINI-ALICATES

ESD

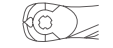

125 mm



125 mm

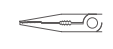

125 mm

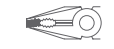

125 mm



Ref 237-080

~~91,65 €~~ **53,90 €**



8 CHAVES

DE BOCAS



6x7 · 8x9 · 10x11 · 12x13

14x15 · 16x17 · 18x19 · 20x22



Ref 450-080

~~80,05 €~~ **47,09 €**



8 CHAVES

BOCA/LUNETAS



8 · 10 · 11 · 12 · 13 · 14 · 17 · 19



Ref 451-080

~~90,54 €~~ **53,26 €**



8 CHAVES

DE LUNETAS DIREITAS



6x7 · 8x9 · 10x11 · 12x13

14x15 · 16x17 · 18x19 · 20x22



Ref 454-080

~~116,63 €~~ **68,60 €**



8 CHAVES

TUBULARES DUPLAS



6x7 · 8x9 · 10x11 · 12x13

14x15 · 16x17 · 18x19 · 20x22



Ref 460-080

~~181,03 €~~ **106,49 €**



3 CHAVES AJUSTÁVEIS

DE MOLETA LATERAL



150mm · 200mm · 250mm



Ref 491-080

~~125,50 €~~ **73,82 €**



3 CHAVES AJUSTÁVEIS

DE MOLETA CENTRAL



150mm · 200mm · 250mm



Ref 493-080

~~94,55 €~~ **55,62 €**



BANDEJAS COMBINÁVEIS PARA OS CARROS DE OFICINA



6 CHAVES DE PARAFUSOS INDUSTRIAL PLUS

- Reta
3 · 4 · 5 · 6
- PH1 · PH2

Ref 300-080
~~65,26 €~~ **38,38 €**

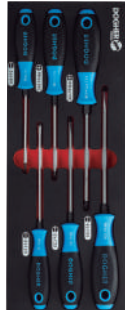

6 CHAVES DE PARAFUSOS INDUSTRIAL PLUS

- Reta
3 · 4 · 5 · 6
- PZ1 · PZ2

Ref 300-081
~~65,26 €~~ **38,38 €**



6 CHAVES DE PARAFUSOS INDUSTRIAL PLUS

- T10 · T15 · T20
T25 · T30 · T40

Ref 303-080
~~59,61 €~~ **35,07 €**



5 CHAVES DE PARAFUSOS INDUSTRIAIS

- Reta
5,5 · 6,5
- PH1 · PH2 · PH3

Ref 315-080
~~53,05 €~~ **31,21 €**



5 CHAVES DE PARAFUSOS INDUSTRIAIS

- Reta
5,5 · 6,5
- PZ1 · PZ2 · PZ3

Ref 315-081
~~51,96 €~~ **30,57 €**



5 CHAVES DE PARAFUSOS PROFISSIONAIS

- Fenda
5,5 · 6,5
- PH1 · PH2 · PH3

Ref 330-080
~~46,13 €~~ **27,13 €**

- Fenda
4 · 5,5
- PH1 · PH2 · PH3

Ref 330-085
~~44,09 €~~ **25,93 €**



5 CHAVES DE PARAFUSOS PROFISSIONAIS

- Fenda
5,5 · 6,5
- PZ1 · PZ2 · PZ3

Ref 330-081
~~47,88 €~~ **28,16 €**



6 CHAVES DE PARAFUSOS ANTIDERRAPANTE

- Reta
3 · 4 · 5,5 · 6,5
- PH1 · PH2

Ref 351-080
~~48,90 €~~ **28,76 €**



6 CHAVES DE PARAFUSOS ANTIDERRAPANTE

- Reta
3 · 4 · 5,5 · 6,5
- PZ1 · PZ2

Ref 351-081
~~50,08 €~~ **29,46 €**



7 CHAVES DE PARAFUSOS ISOLADAS 1000V

- Reta
3 · 4 · 5,5 · 6,5
- PH0 · PH1 · PH2

Ref 360-080
~~76,97 €~~ **45,28 €**



7 CHAVES DE PARAFUSOS ISOLADAS 1000V

- Reta
3 · 4 · 5,5 · 6,5
- PZ0 · PZ1 · PZ2

Ref 360-081
~~77,55 €~~ **45,62 €**



3 ALICATES DE PRESSÃO



125mm · 175mm · 250mm

Ref 276-080
~~84,50 €~~ **49,71 €**



2 MARTELOS

Martelo de rebite 320g
Ref 702-320

Martelo boca de Nylon Ø 35
Ref 742-35

Ref 700-080
~~59,05 €~~ **34,74 €**



26 PEÇAS

CHAVES DE CAIXA COM PONTA 1/2"

- 4 · 5 · 6 · 7 · 8 · 10
12 · 14 · 17 · 19
T20 · T25 · T27 · T30
T40 · T45 · T50 · T55 · T60
- 5 · 6 · 8 · 10 · 12 · 14 · 16



Ref 534-080
~~398,47 €~~ **222,68 €**

12 PEÇAS

SERIE LONGA

CHAVES DE CAIXA COM PONTA 1/2"

- 100 mm: 5 · 6 · 7 · 8 · 12
140 mm: 5 · 10
- 120 mm: T40 · T55
- 100 mm: 8 · 10 · 12



Ref 538-080
~~246,96 €~~ **138,00 €**

18 PEÇAS

SERIE LONGA

CHAVES DE CAIXA 1/4" 3/8" 1/2"

- 4 · 5 · 6 · 7
8 · 9 · 10
- 10 · 11 · 12 · 13 · 14 · 15
- 16 · 17 · 18 · 19 · 22



Ref 502-080
~~231,48 €~~ **129,35 €**

29 PEÇAS

CHAVES DE CAIXA TORX DE 1/4" E 1/2"

- E10 · E11 · E12 · E14 · E16
E18 · E20 · E22 · E24
TS20 · TS25 · TS27 · TS30
TS40 · TS45 · TS50 · TS55 · TS60
- E4 · E5 · E6 · E7 · E8
T6 · T7 · T8 · T9 · T10 · T15



Ref 503-080
~~316,58 €~~ **176,93 €**

22 PEÇAS

CHAVES DE CAIXA SEXTAVADAS 3/8"

- 6 · 7 · 8 · 9 · 10 · 11 · 12 · 13 · 14
15 · 16 · 17 · 18 · 19 · 20 · 21 · 22

Roquete de 72 dentes



Articulação universal



Extensor: 75 e 150 mm



Cabo Corrediço em T



Ref 516-080
~~250,23 €~~ **139,85 €**

46 PEÇAS

CHAVES DE CAIXA SEXTAVADAS OU 12 FACES 1/4"

- 4 · 4,5 · 5 · 5,5 · 6 · 7 · 8 · 9 · 10 · 11 · 12 · 13 · 14
Serie longa: 6 · 7 · 8 · 9 · 10 · 11 · 12 · 13 · 14
- HX3 · HX4 · HX5 · HX6 · HX7 · HX8
- PH1 · PH2 · PH3 PZ1 · PZ2
- T10 · T15 · T20 · T25 · T30 · T40

- Roquete de 72 dentes
- Articulação universal
- Extensor: 50 e 100 mm
- Extensor flexível 145 mm
- Chave
- Cabo corrediço em T



1/4"



Hexagonal

Ref 500-081 ~~407,73 €~~ **227,84 €**

Bihexagonal

Ref 501-081 ~~407,73 €~~ **227,84 €**

13 SACA-TROÇOS

E PUNÇÕES

- Ref 7446 3x10 6x10
4x10 8x12
5x10 10x12

- Ref 7449 2,5x7 4x8
3x7 6x10
3,5x8 8x12

Ref 750-013



Ref 7446-080
~~133,05 €~~ **78,26 €**



3 ORGANIZADORES

Ref 010-080
~~40,53 €~~ **23,84 €**



3 FERRAMENTAS

PARA ELETRICISTA

Tesoura descarna fios

Ref 296-003

Alicate para cravar terminais

Ref 296-056

Descarna-fios automático

Ref 296-051



Ref 296-080
~~87,29 €~~ **51,34 €**

4 ALICATES

ISOLADOS 1000V

240 mm

160 mm

160 mm

180 mm

160 mm

180 mm



Ref 250-081
~~182,86 €~~ **107,57 €**



4 ALICATES

PROFISSIONAIS

160 mm

250 mm

180 mm

160 mm

180 mm

160 mm

Ref 205-081
~~121,22 €~~ **71,31 €**



10 CHAVES DE PARAFUSOS

PROFISSIONAIS E ISOLADAS 1000V

- Reta
4 · 5,5 · 6,5
- PH1 · PH2
- Plana
4 · 5,5 · 6,5
- PH1 · PH2

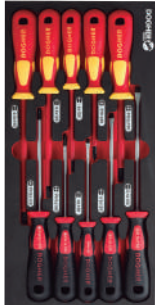

Ref 330-084

~~98,33 €~~ **57,84 €**

7 CHAVES DE PARAFUSOS

PROFISSIONAIS

- Plana
3 · 4 · 5,5 · 6,5
- PH0 · PH1 · PH2

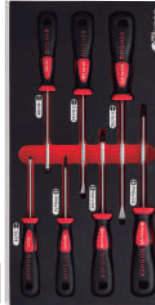

Ref 330-082

~~55,02 €~~ **32,37 €**

7 CHAVES DE PARAFUSOS

PROFISSIONAIS

- Plana
3 · 4 · 5,5 · 6,5
- PZ0 · PZ1 · PZ2

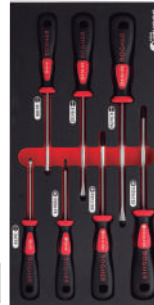

Ref 330-083

~~56,53 €~~ **33,25 €**

10 CHAVES

DE BOCAS



6x7 · 8x9 · 10x11 · 12x13
14x15 · 16x17 · 18x19
20x22 · 21x23 · 24x26



Ref 450-081

~~115,49 €~~ **67,93 €**

3 CHAVES

DE BOCAS



25x28 · 27x29 · 30x32



Ref 450-082

~~83,26 €~~ **48,97 €**

10 CHAVES

BOCA/LUNETA



8 · 10 · 11 · 12 · 13
14 · 17 · 19 · 22 · 24



Ref 451-081

~~129,91 €~~ **76,41 €**

11 CHAVES

BOCA/LUNETA

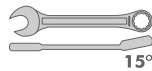

15°

7 · 8 · 10 · 11 · 12 · 13
14 · 17 · 19 · 22 · 24



Ref 451-082

~~136,61 €~~ **80,35 €**

3 CHAVES

BOCA/LUNETA



27 · 30 · 32



Ref 451-083

~~106,67 €~~ **62,75 €**

6 CHAVES

DE LUNETAS 75°

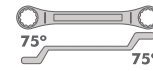

75°

8x9 · 10x11 · 12x13
14x15 · 16x17 · 18x19

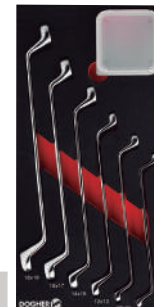

Ref 453-080

~~108,86 €~~ **64,03 €**

9 PEÇAS

6 CHAVES COM ROQUETE REVERSÍVEL
3 QUADRAS DE ARRASTRO

1/4" · 3/8" · 1/2"

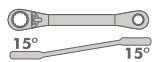

15°

8x9 · 10x11 · 12x13
14x15 · 16x18 · 17x19



Ref 455-080

~~294,32 €~~ **173,13 €**

10 PEÇAS

7 CHAVES COM ROQUETE REVERSÍVEL
3 QUADRAS DE ARRASTRO



1/4" · 3/8" · 1/2"



15°

10 · 12 · 13 · 14 · 15 · 17 · 19



Ref 457-080

~~288,92 €~~ **169,96 €**

7 CHAVES DE BOCA

ROQUETE REVERSÍVEL



15°

8 · 10 · 13 · 15 · 17 · 19 · 22



Ref 457-081

~~268,33 €~~ **157,85 €**

6 CHAVES

DE CAIXA FLEXÍVEIS



8x9 · 10x11 · 12x13
14x15 · 16x17 · 18x19



Ref 467-080

~~170,31 €~~ **95,18 €**

36 PEÇAS

CHAVES DE CAIXA SEXTAVADAS 1/4"

- Jogo de chaves em navalha: 1,5 · 2 · 2,5 · 3 · 4 · 5 · 6 · 8
- 5,5 · 6 · 7 · 8 · 9 · 10 · 11 · 12 · 13 Serie Larga: 6 · 8 · 10 · 12 · 13
- 1/4" PH1 · PH2 · PH3 PZ1 · PZ2 · PZ3
- HX3 · HX4 · HX5 HX6 · HX7 4 · 5,5 · 6,5

Roquete de 72 dentes
Articulação universal
Extensor: 50 e 100 mm
Cabo corrediço em T
Chave

Adaptador para espaços reduzidos

Ref 500-083

~~340,43 €~~ 190,24 €



27 PEÇAS

CHAVES DE CAIXA SEXTAVADAS 1/2"

- 1/2" 8 · 9 · 10 · 11 · 12 · 13 · 14 · 15 · 16 · 17
- 18 · 19 · 20 · 21 · 22 · 23 · 24 · 27 · 30 · 32
- Para Bujias: 16 · 21

Roquete de 72 dentes

Adaptador tripla função

Extensor: 125 e 250 mm

Articulação universal

Hexagonal Ref 531-080 ~~341,00 €~~ 190,54 €

Bihexagonal Ref 530-080 ~~341,00 €~~ 190,54 €



25 PEÇAS

CHAVES DE IMPACTO 1/2"

- 1/2" 8 · 9 · 10 · 11 · 12 · 13 · 14 · 15 · 16
- 17 · 18 · 20 · 21 · 22 · 24
- Serie longa: 17 · 19 · 21 · 22 · 24
- Chaves caixa cor: 17 · 19 · 21

Articulação universal de impacto

Extensor: 125 mm

Ref 570-080

~~416,59 €~~ 245,06 €



23 PEÇAS

CHAVES DE IMPACTO 1/2"

- 1/2" E10 · E12 · E14 · E16 · E18 · E20 · E24
- T25 · T27 · T30 · T40 · T45 · T50 · T55 · T60
- 5 · 6 · 8 · 10 · 12 · 14 · 17 · 19

Ref 572-080

~~541,34 €~~ 302,53 €



7 PEÇAS

CHAVE CORREDIÇA EM "T" 3 PONTAS SEXTAVADAS

- 2 · 2,5 · 3 · 4 · 5 · 6 · 8

Ref 623-080

~~180,88 €~~ 106,40 €



9 PEÇAS

PERCUSSÃO

- Martelo Rivoir Punho Fibra de Vidro 35 mm
- Saca Troços Cilíndrico 3x10mm
- Saca Troços Cilíndrico 4x10mm
- Saca Troços Cilíndrico 5x10mm
- Saca Troços Cilíndrico 6x10mm
- Saca Troços Cilíndrico 8x12mm
- Saca Troços Cilíndrico 10x12mm
- Martelo de Nylon Punho Fibra de Vidro 35 mm
- Escopro Cortafrios 13x23x30x250 mm

Ref 729-080

~~134,75 €~~ 79,25 €



8 ALICATES

CIRCLIP® PRO

- 140 / 180 mm
- 140 / 180 mm
- 140 / 180 mm
- 140 / 180 mm

Ref 220X-081

~~247,59 €~~ 145,65 €



11 CHAVES

DE CACHIMBO 6X6

- 8 · 10 · 11 · 12 · 13 · 14
- 15 · 16 · 17 · 18 · 19

Ref 462-080

~~234,61 €~~ 138,00 €



43 PEÇAS

CHAVES DE CAIXA 1/4" E 1/2" SEXTAVADAS OU 12 FACES

1/2" 10 · 11 · 12 · 13 · 14 · 15 · 16 · 17 · 18 · 19 · 20 · 21
22 · 24 · 27 · 30 · 32 para as velas: 16 · 21

1/4" 4 · 4,5 · 5 · 5,5 · 6 · 7 · 8
9 · 10 · 11 · 12 · 13 · 14

- Roquete de 72 dentes
- Adaptador tripla função
- Extensor: 125 e 250 mm
- Articulação universal

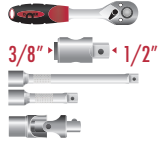

- Roquete de 72 dentes
- Extensor: 50 e 100 mm
- Articulação universal
- Chave
- Cabo correção em T



	Hexagonal	Ref 500-080	487,51 €	258,10 €
	Bihexagonal	Ref 501-080	487,51 €	258,10 €

10 CHAVES EM T SEXTAVADAS E COM PONTA ESFÉRICA

2 · 2,5 · 3 · 4 · 5 · 6 · 7 · 8 · 10 · 12

	Ref 618-080
171,10 €	100,63 €



10 CHAVES EM T SEXTAVADAS RETAS

2 · 2,5 · 3 · 4 · 5 · 6 · 7 · 8 · 10 · 12

	Ref 617-080
170,05 €	100,03 €

10 CHAVES EM T TORX SEGURANÇA

TS9 · TS10 · TS15 · TS20 · TS25 · TS27 · TS30 · TS40 · TS45 · TS50

	Ref 620-080
145,67 €	85,69 €

4 ALICATES DE PRESSÃO

Part N° 275F-010 · 275F-011
275F-012 · 275F-013

	Ref 275F-080
357,40 €	210,24 €



3 PERCUSSÃO

Part N° 7310-50 · 700-680 · 7331-35



	Ref 700-085
147,92 €	87,01 €

5 ELETRICISTA

Part N° 795-002 · 296-132 · 296-152
296-060 · 204-200



	Ref 795-080
215,19 €	126,59 €

6 ALICATES SETOR AUTO

Part N° 2200-005 · 2200-010 · 2200-011
2200-012 · 2200-30 · 2200-25



	Ref 2200-080
360,15 €	211,85 €

31 PEÇAS

MULTI-FERRAMENTA

- Martelo Nylon Anti-Recoo Batente Pressão 35 mm
- Martelo de Bola Punho hickory 455 grs.
- Fita Métrica Magnética de 3 m
- X-Ato com Parafuso de Bloqueio 18 mm
- Lima Chata 200 mm Punho Bimaterial Grão Entrefino
- Lima Chata 200 mm Punho Bimaterial Grão Basto
- Tesoura Electricista Profissional 145 mm
- Jogo de Chaves Macho Sextavadas Ponta-Esférica XL 9 peças 1,5-10
- 10 Folhas de Serra de Mão Bimetálicas 300x13x0,65
- Arco de Serra Profissional Reforçado 300 mm

- Saca Traços Cilíndrico 4x10 mm
- Saca Traços Cilíndrico 5x10 mm
- Saca Traços Cilíndrico 6x10 mm
- Alicate Ajuste Rápido com Botão 240 mm

	Ref 840-080
296,82 €	174,59 €



155 PEÇAS

MULTI-FERRAMENTA



1/4" Bits 1/4" · 25 mm

PH0 · PH1 · PH2 · PH3 · PH4

PZ0 · PZ1 · PZ2 · PZ3 · PZ4

3 · 3,5 · 4 · 4,5 · 5 · 5,5 · 6 · 6,5 · 8

T5 · T6 · T7 · T8 · T9 · T10 · T15 · T20 · T25 · T27 · T30 · T40

HX1,5 · HX2 · HX2,5 · HX3
HX4 · HX5 · HX6 · HX8 · HX10

R1 · R2 · R3

TS10 · TS15 · TS20
TS25 · TS27 · TS30 · TS40

1/4" Bits 1/4" · 50 mm

PH1 · PH2 · PH3 · PH4

PZ1 · PZ2 · PZ3 · PZ4

3 · 3,5 · 4 · 4,5 · 5 · 5,5 · 6 · 6,5 · 8

HX2 · HX2,5 · HX3
HX4 · HX5 · HX6 · HX8

R1 · R2 · R3

T5 · T6 · T7 · T8 · T9 · T10 · T15 · T20 · T25 · T27 · T30 · T40

5/16" Bits 5/16" · 30 mm

T40 · T45 · T50 · T55

Ref 500-084

448,45 € 263,79 €

1/4"

Roquete 72 dentes (510-001)

Extensões 150 mm (509-007)
50 mm (509-006)

Articulação Universal (509-009)

4-4,5-5-5,5-6-7-8-9-10-11-12-13-14

1/2"

Roquete 72 dentes (544-001)

Extensões 125 mm (543-003)
75 mm (543-002)

Articulação Universal (543-009)

Punho

• DOGHER (509-017)

Adap. Cabo Sextavado para Chaves de Caixa
• 1/4" · 1/4" (509-019)

Porta-bits com quadra de arrasto

• 1/4" · 1/4" (509-012)

4

4,5-7-8-10-11-13

Porta-Bits com Quadra de Arrasto

• 1/2" · 5/16" (543-018)

Porta-Bits com Quadra de Arrasto

• 1/2" · 1/4" (543-028)

8-9-10-11-12-13-14-15
16-17-19-22-24-25-27-30

9

10-11-13-17-19

9 Pcs



(605-009)

1,5-2-2,5-3-4-5-6-8-10 mm

Jogo de Chaves Macho Ponta Esférica Sextavada Extra Longa

AMPLA GAMA

DE ESCOVAS



Para mais informações consulte as páginas 410-420 do catálogo 2023-2024.

PROMOÇÃO
2025

PROLIGHT

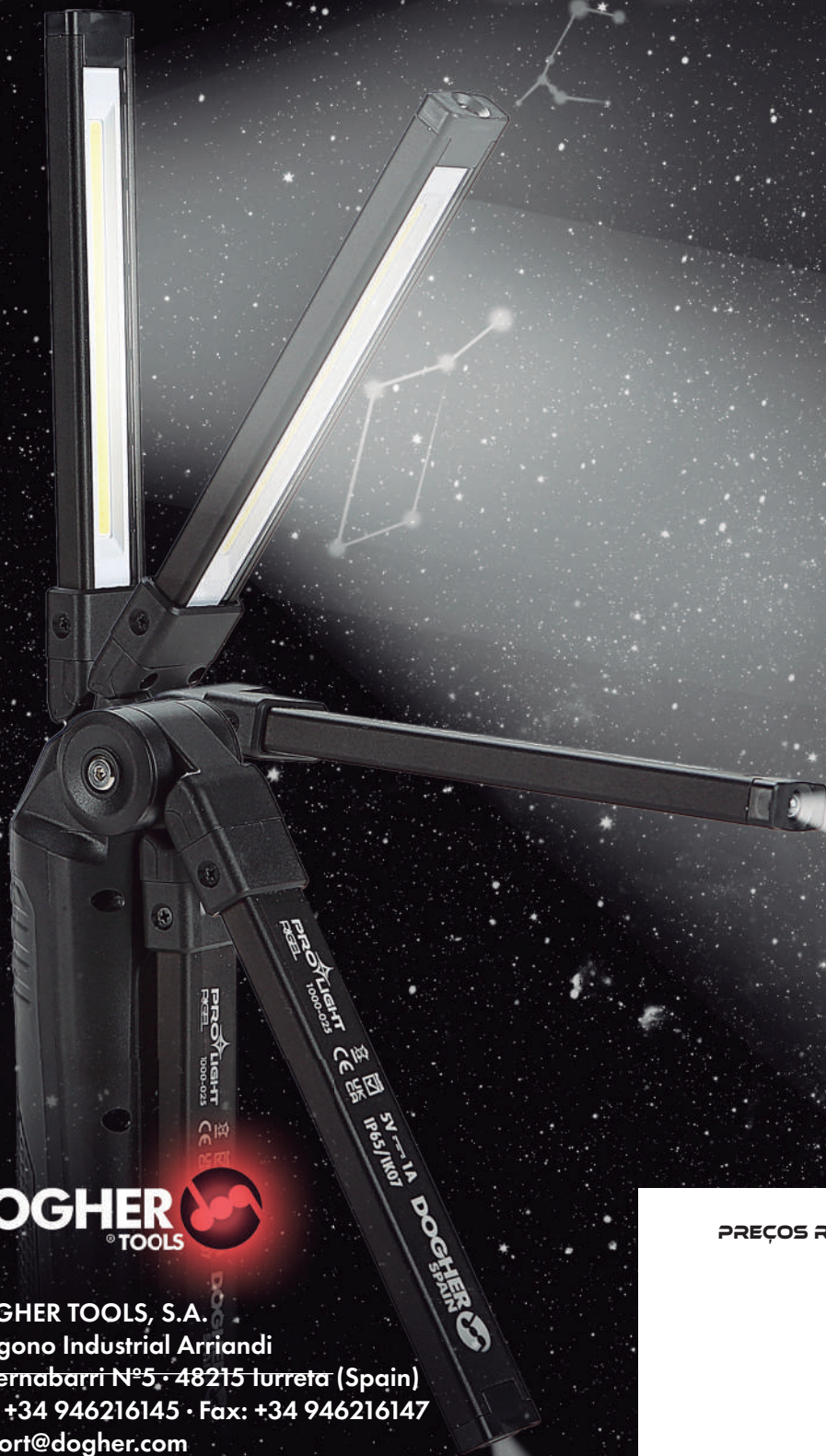

DOGHER
TOOLS

DOGHER TOOLS, S.A.
Polígono Industrial Arriandi
Tabernabarrí Nº5 · 48215 Iurreta (Spain)
Tel.: +34 946216145 · Fax: +34 946216147
exporti@dogher.com

www.dogher.com

PROMO2025PT



PREÇOS RECOMENDADOS - IVA NÃO INCLUIDO

Promoção em vigor desde o 17/02/2025